

ELEKSEC

Company: Zhongshan City EOS Secure Products Co., Ltd.
Email: winny@eos-secure.com
Mobile: +86 13420436003
Add: No.29 Ronghua South Road, Xiaolan Town,
Zhongshan City 528415, Guangdong, China

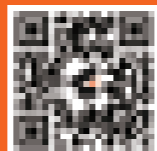

 ELEKSEC



2026 CATALOGUE

RETROFIT SMART LOCK
MANUFACTURER

[HTTPS://WWW.ELEKSEC.COM/](https://www.eleksec.com/)



CATALOG

1

■ ABOUT ELEKSEC -04

2

■ WHY ELEKSEC -05

- QUALITY CONTROL YOU CAN RELY ON
- ADVANCED MANUFACTURING CAPABILITIES
- ONE-STOP R&D SOLUTION
- SALES & MARKETING SUPPORT

3

■ TAILORED SOLUTIONS -15

- HOME SMART ACCESS
- VACATION RENTAL & HOSPITALITY
- COMMERCIAL & SME ACCESS

4

■ PATENTS & CERTIFICATIONS -21

5

■ CORE PRODUCT PORTFOLIO -23

- RETROFIT MOTORIZED SMART LOCK (D2)
- SMART LOCK CYLINDERS (D1 PLUS, D3)
- SMART HANDLE SET (K1, K2, K3, K4, AS1, AU1)
- SMART LEVER HANDLE LOCK (H1)
- SMART KEY BOX (B2, B3)
- SMART CYLINDER PROTECTOR (EP1)
- SMART RIM LOCK (R1)
- ACCESSORIES
(KEYPAD, WI-FI GATEWAY, DOOR SENSORS)

ABOUT



10+

Years of Experience

6

Core R&D Engineers

10

QC Specialists

±0.01

mm CNC Precision

ELEKSEC is a professional retrofit smart lock manufacturer with over 10 years of experience in mechanical door hardware manufacturing. Our background in producing high-quality mortise locks and high-precision lock cylinders provides a solid mechanical foundation for developing high-end retrofit motorized smart lock solutions.

This long-term experience enables us to maintain higher standards in manufacturing processes, quality control, and supply chain integration -- especially for products that require long-term stability, precision, and reliability.

With a strong reputation within the industry, we have established close technical cooperation with leading smart lock platform providers such as Tuya and TTLock. Their continuous support allows us to accelerate product development cycles and deliver market-ready solutions more efficiently.

In parallel, we have also developed our own electronic locking system, demonstrating our long-term commitment and capabilities in embedded software and system-level R&D.



OEM / ODM

From concept to mass production



Platform-ready

Tuya & TTLock cooperation



Fast iteration

Accelerated development cycles



Global markets

EU, ME, RU, AU, SA



10+

Years average industry experience

Internationally Recognized Certifications



From raw material intake to final packaging, every product passes through multiple checkpoints to guarantee consistency, precision, and reliability.



Durability Testing

Automated endurance testing machines simulate tens of thousands of lock/unlock cycles to validate mechanical lifespan and motor reliability.



Aging Testing

Extended aging tests stress electronic components and assemblies under continuous operation to identify potential early-failure risks.



Temperature Testing

High and low temperature chambers test product performance across extreme climate conditions, ensuring reliability in diverse global markets.

Advanced Manufacturing Capabilities

Industry-leading equipment and processes that deliver superior accuracy, consistency, and scalability -- from precision CNC machining to smartphone-grade surface finishing and high-reliability PCB production.



- **Tsugami Swiss-type CNC machines (6-axis, 5-axis, 3-axis) with ± 0.01 mm precision**
- **Fully automated multi-axis CNC machining centers**

Smartphone-industry-level plastic molding and surface finishing



3C-Grade Plastic Molding

Ultra-precise molds produce plastic components with exceptional surface smoothness, tight dimensional tolerances, and consistent color matching across production runs.

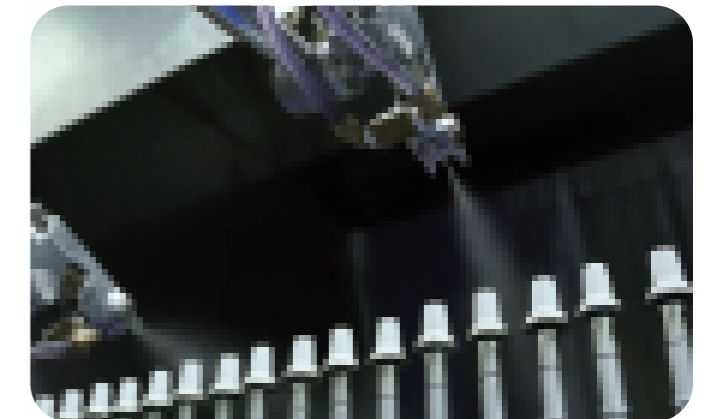

Premium Spray Coating

Industry-leading spray coating processes deliver ultra-fine, uniform surface textures that are scratch-resistant and aesthetically refined.

High-End PCB Manufacturing



FUJI NXT SMT lines

High-speed, high-precision surface mount technology for consistent component placement and soldering quality.



AOI inspection

High-precision automated optical detection systems catch defects invisible to the human eye, ensuring zero-defect output.

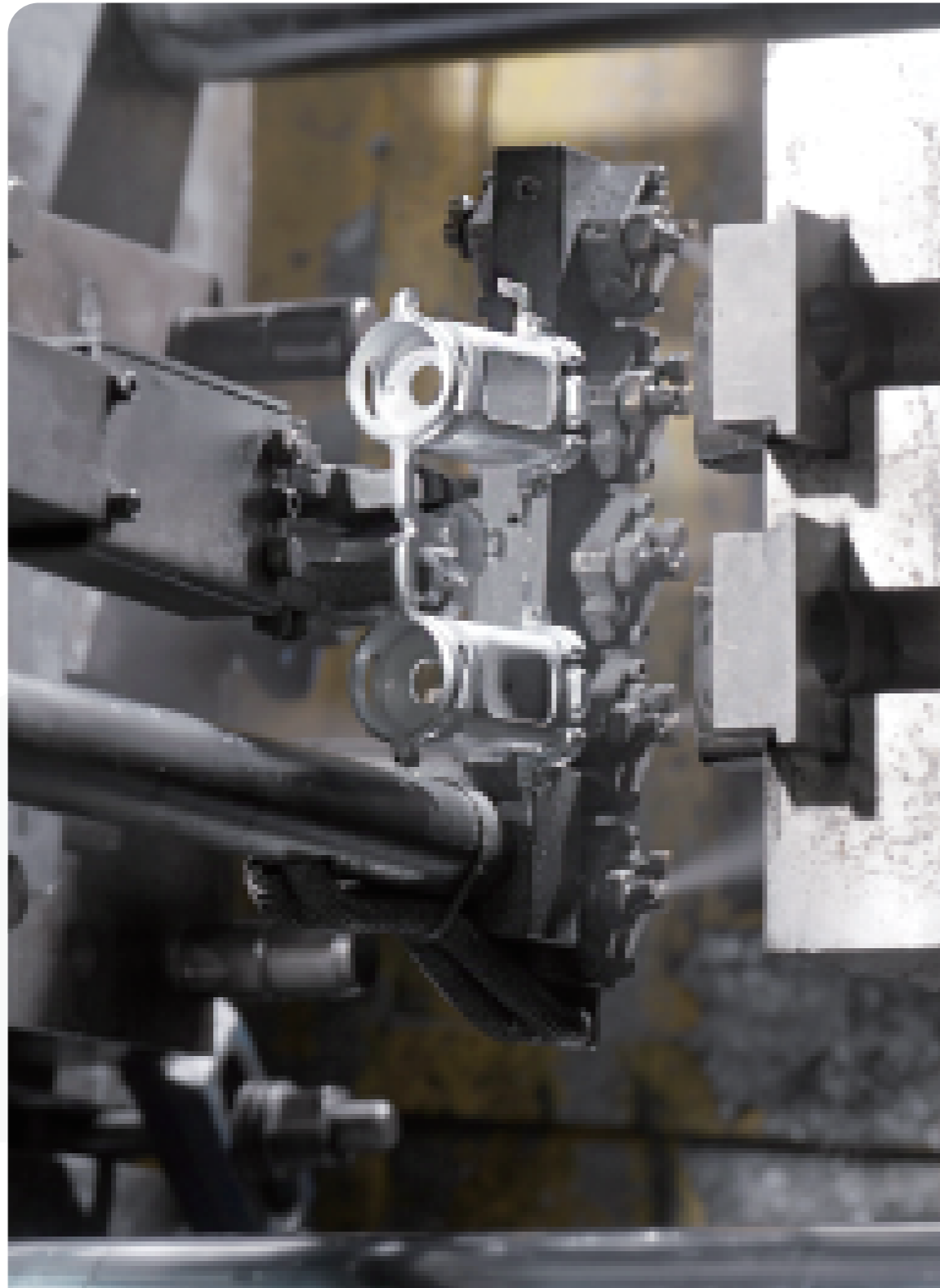

Automatic Die-Casting Machines

Automatic Robot Arm Polishing Machines

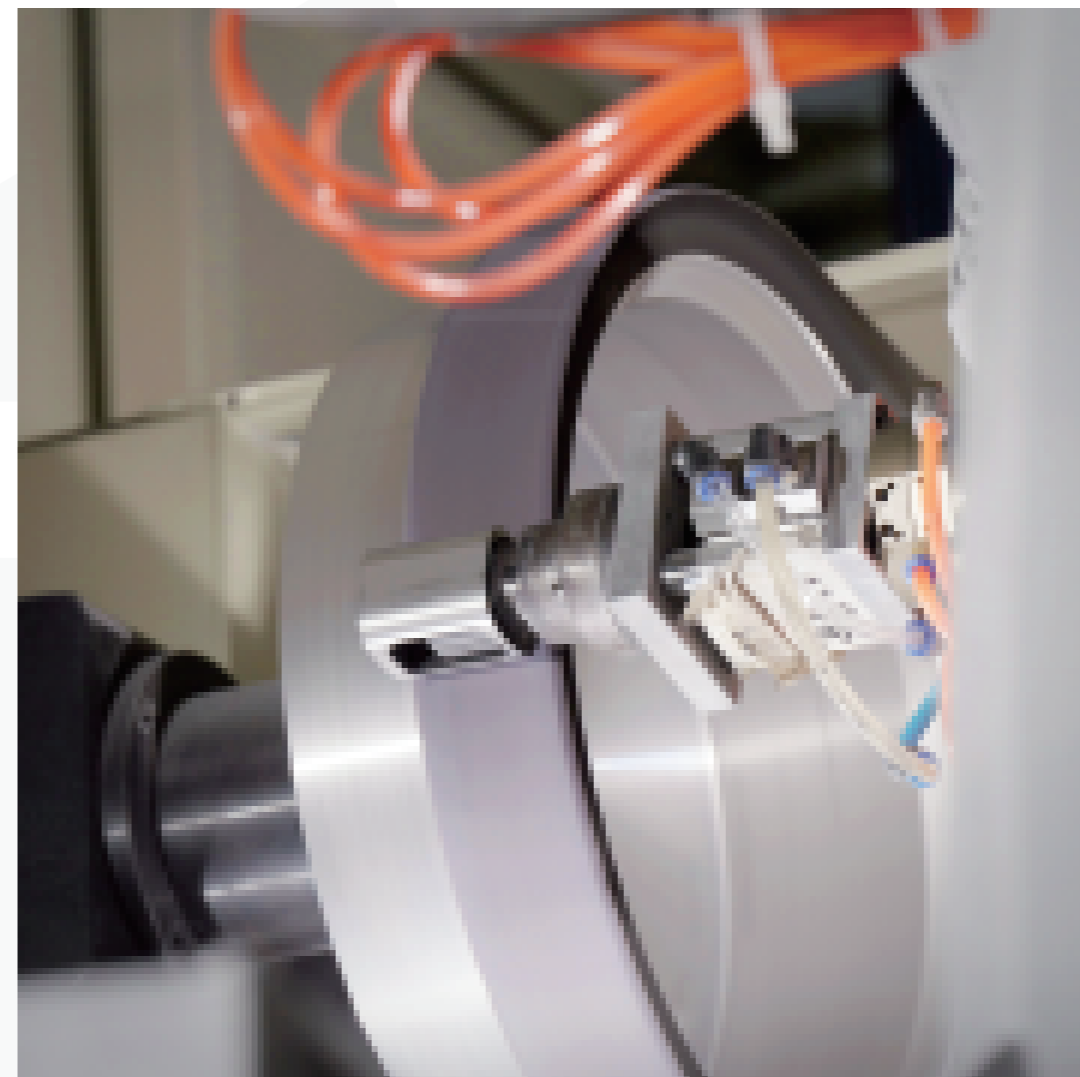

One-Stop R&D Solution

A Core Team Built for Precision

From initial concept to mass production -- we deliver end-to-end product development under one roof, reducing coordination risk and accelerating your time to market.



Full-cycle development from concept to mass production

A structured, transparent workflow that takes your product idea from the drawing board to the production line -- with engineering rigor at every stage.



Mechanical, electronic, and PCB design under one system

Circuit schematics and PCB layouts are developed in parallel with the mechanical design. Our electronic engineers handle motor drivers, power management, BLE/Wi-Fi modules, and sensor integration -- all validated



Prototyping, validation, and mass production support

Functional prototypes are assembled and put through rigorous testing -- including endurance cycling, temperature stress, aging tests, and real-door installation trials in our in-house testing laboratory. Issues are identified and resolved before production begins.



Core engineering team with over 10 years of industry experience

Our R&D team of 6 core engineers brings an average of over 10 years of hands-on experience in the smart lock and precision hardware industry. This depth of expertise means fewer design iterations, faster problem-solving, and products that work right from the first production run.

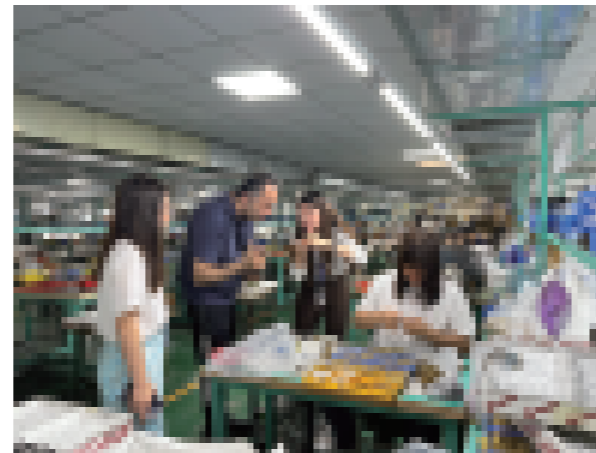
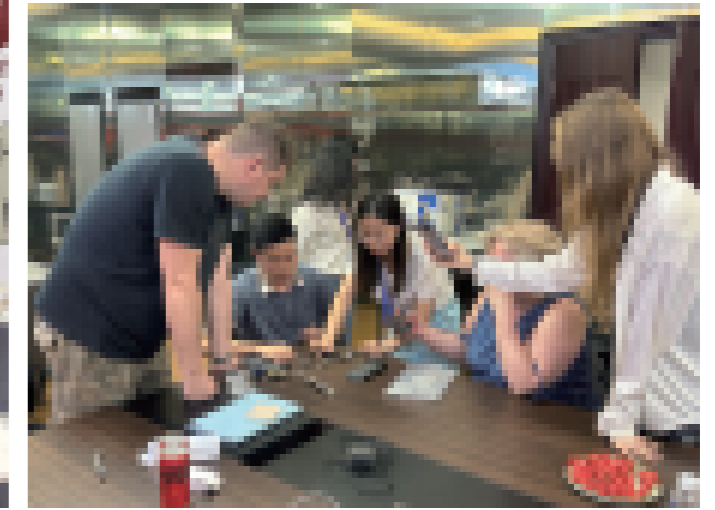
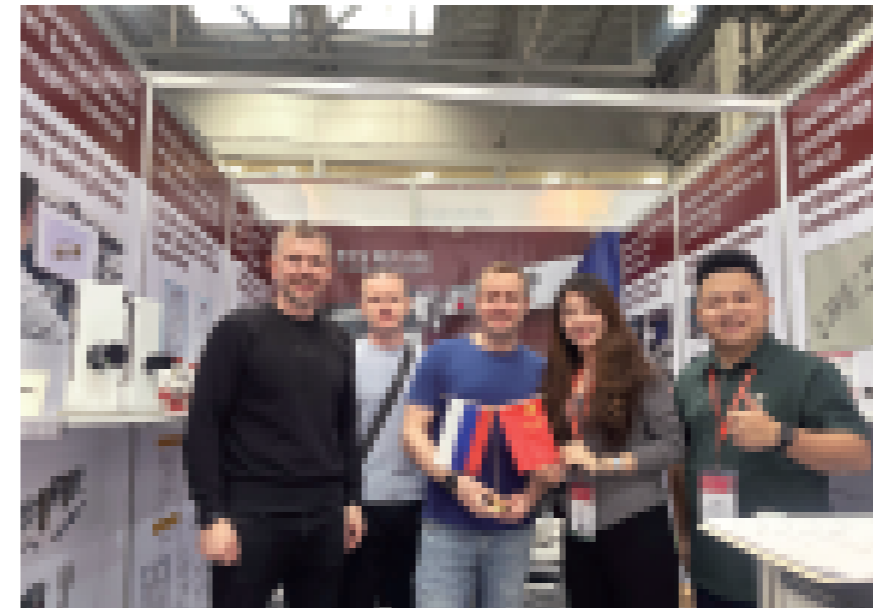

Built for Industry Professionals

SALES & MARKETING SUPPORT

- Professional international sales team with fast response
- Regular visits to target markets by sales, engineers & management
- Customized HD product photos, feature visuals & 3D animations
- OEM & ODM services with marketing material assistance

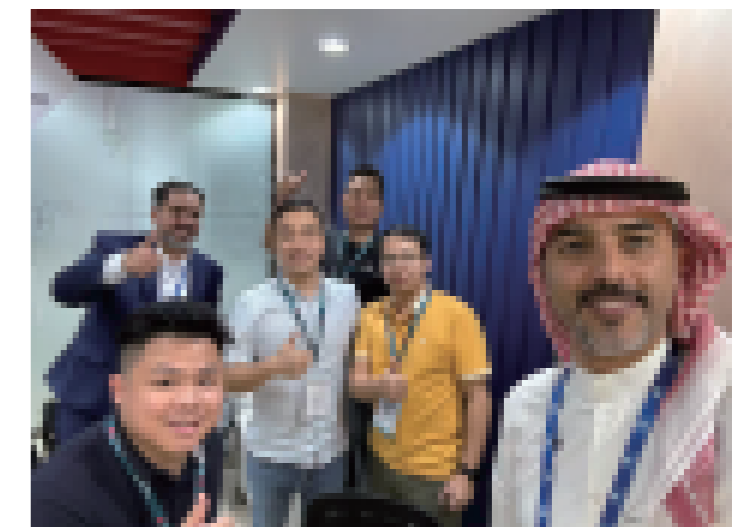



Tuya/TTLOCK BLE Unlock

Seamless Smart Home Ecosystem Integration

HOME SMART ACCESS



- Multiple Keyless Methods
- Electronic Key Sharing
- Smart Home Integration
- Event & Access Logs
- Easy Retrofit Installation
- Fire-Resistant & Safe



Trusted by Rental Operators Worldwide

VACATION RENTAL & HOSPITALITY

- Self-Service Check-In & Check-Out
- PMS Integration
- Channel Manager Compatibility
- Retrofit Installation
- Access Logs & Audit Trail
- Multi-Role Permission Control

Key Advantages for Your Business

COMMERCIAL & SME ACCESSPITALITY

- Centralized Access Management
- Wide Cylinder Compatibility
- One System, Multiple Models
- On-Premise Deployment
- Zero Recurring License Fees
- Dual-Scenario Support



TTLock



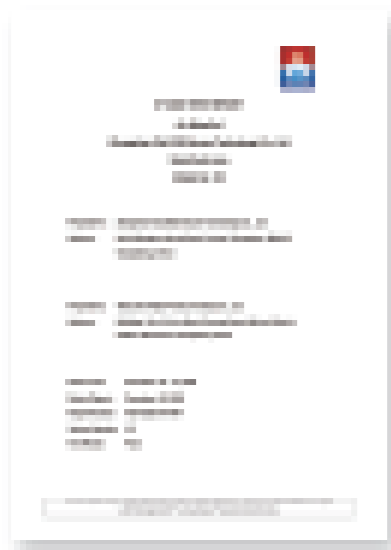

D3 IP68 certificate

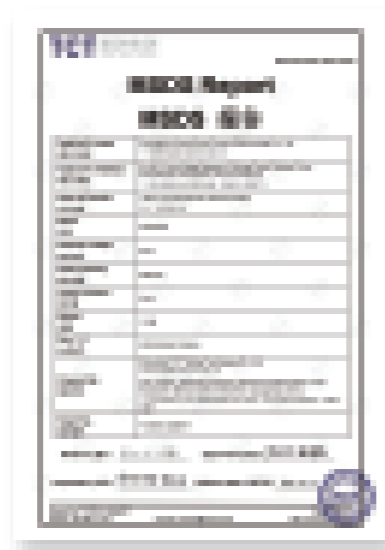

Battery MSDS report

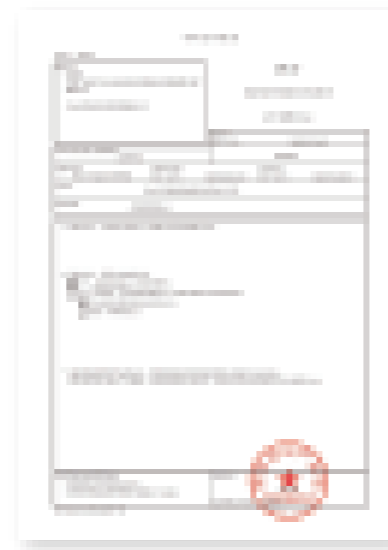

Smart Lock Cylinder Protector
PCT Pending



Retrofit Motorized Smart Lock Appearance Patent



CE certificate



RoHS certificate

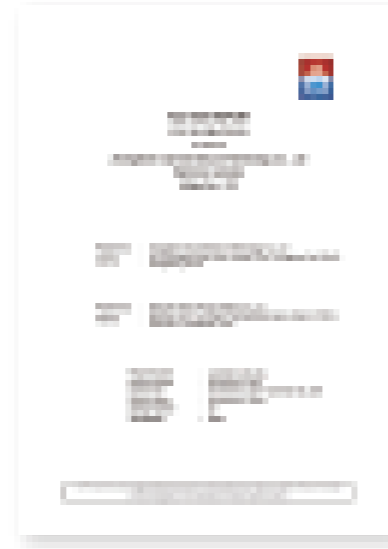

FCC certificate



Smart Lock Cylinder Protector Appearance Patent

COMPANY PATENTS AND CERTIFICATES

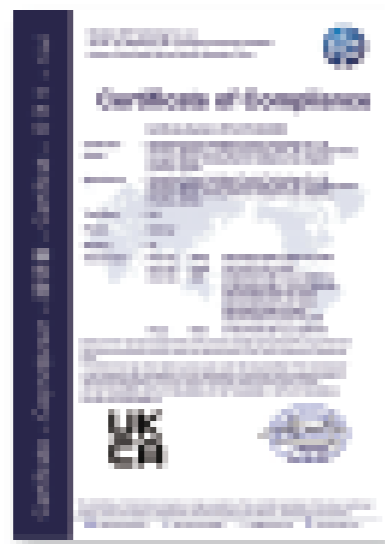

Gateway UKCA certificate

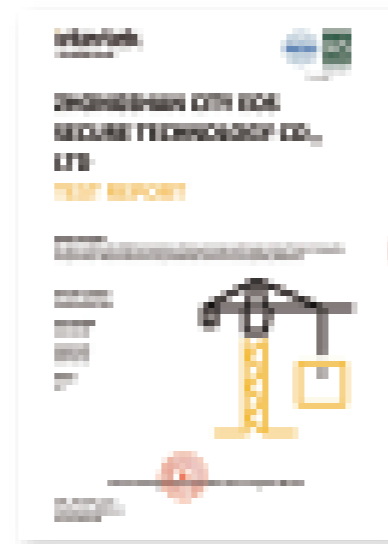

D2 D3 Fire Approval Certification



Smart Lock Cylinder Appearance Patent

ELECTRONIC LOCKING SYSTEM

D2

RETROFIT MOTORIZED
SMART LOCK

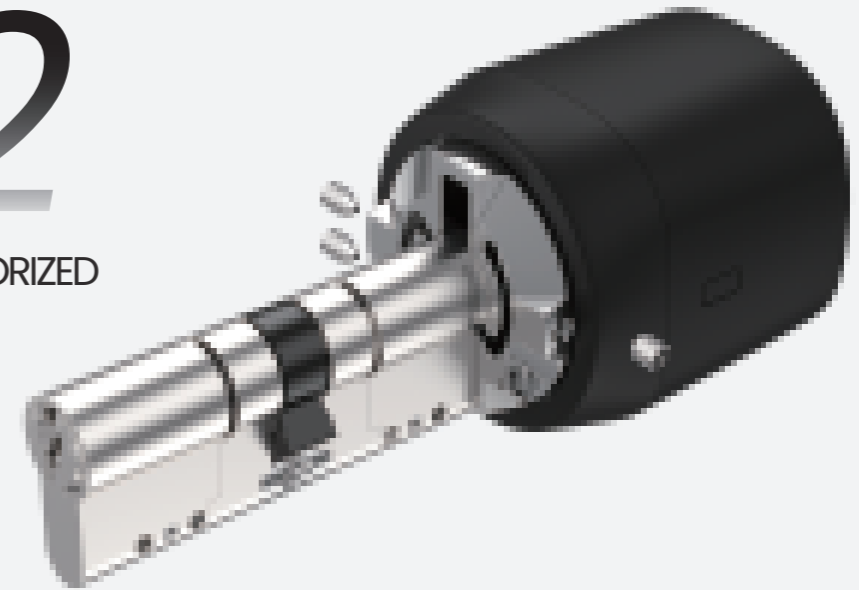

SMART LOCK CYLINDERS
(D1, D1PLUS, D3)

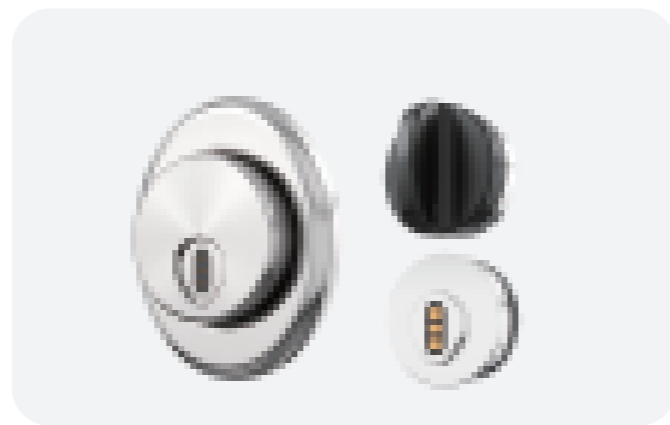

SMART CYLINDER PROTECTOR
(EP1)



SMART LEVER HANDLE LOCK
(H1)



SMART KEY BOX
(B2, B3)



SMART HANDLE SET
(K1, K2, K3, K4, AS1, AU1)



SMART RIM LOCK
(R1)



ACCESSORIES
(KEYPAD, WI-FI GATEWAY, DOOR SENSORS)





PATENT RETROFIT MOTORIZED SMART LOCKS

- Motor power is over 3Nm. Suitable for heavy mortise locks.
- TTLOCK apps remote unlock (through Gateway), BLE distance unlock, Mechanical key unlock.
- With Gateway and door sensor (extra purchase), you can check the real-time door and lock status.
- With IPX5 rating Keypad (extra purchase), you can unlock by passcodes, fingerprint and card.
- Access management for private, commercial, office, hotel and apartment. (Recommend TTLOCK Application)
- CE, FCC, RoHS, Fire rated 100Hrs certified.
- Working temperature: -25 degree to 70 degree.
- 3 pcs of CR123A-3V battery and 1-year battery life.
- OEM and ODM service available, including offering APP SDK file and API.



Converter:

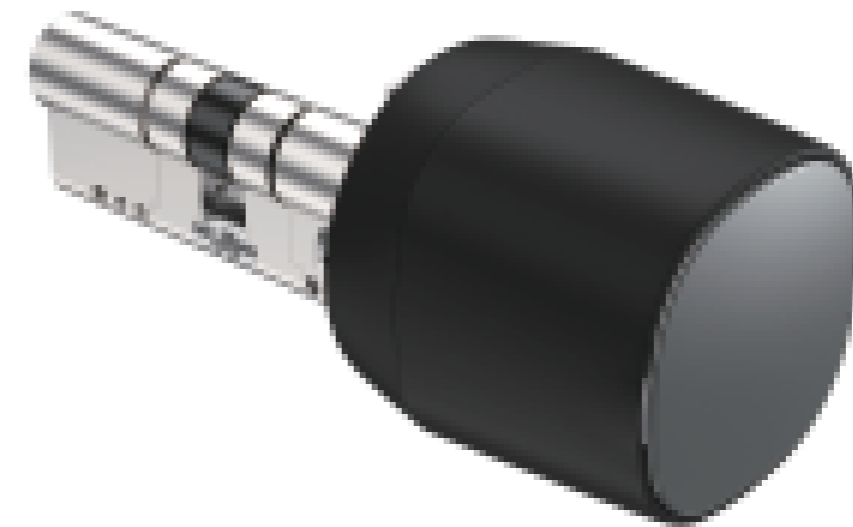
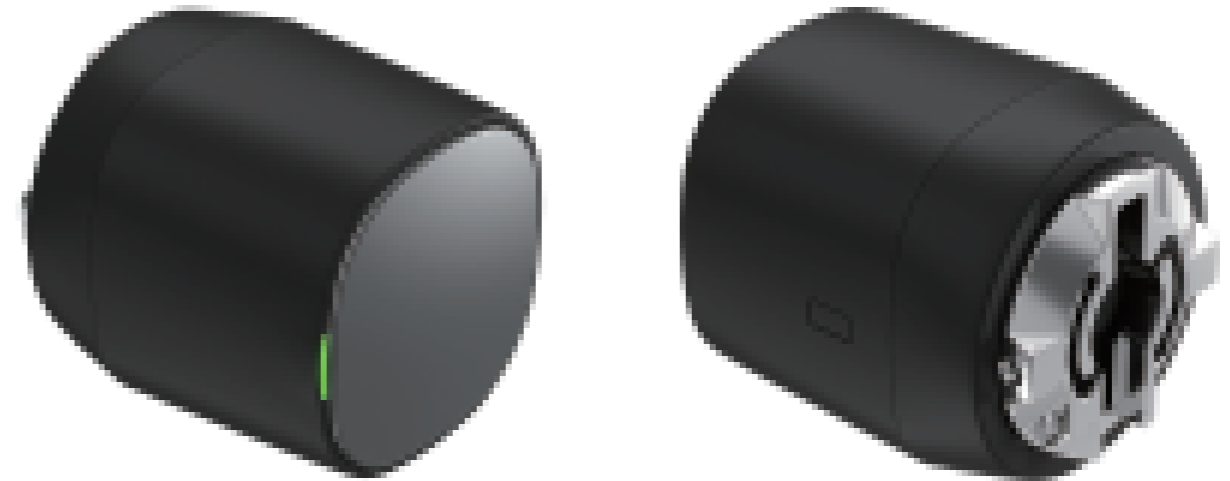

TTLock



D2-M



WiFi Gateway

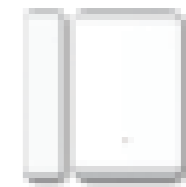

Door Sensor

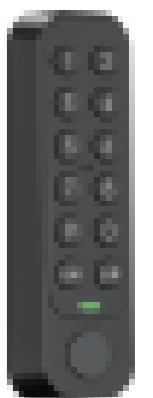

Keypad

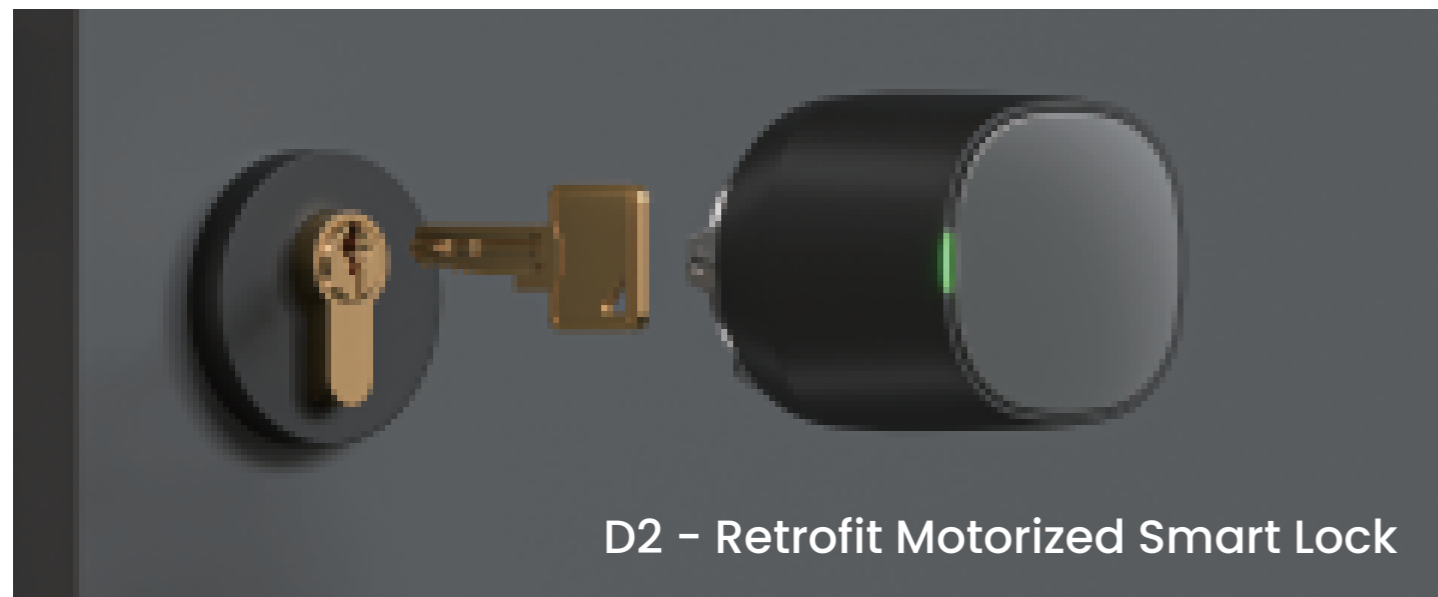

Easy to install

No need to replace the lock cylinder !

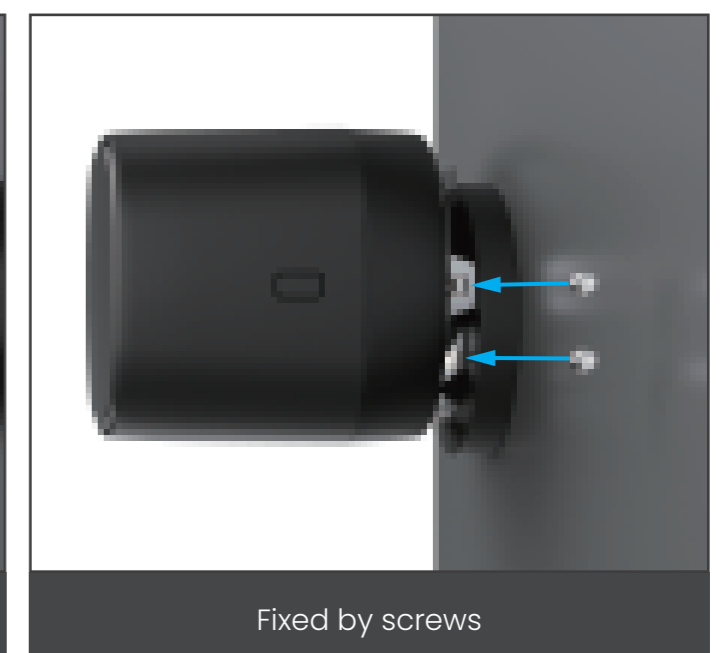
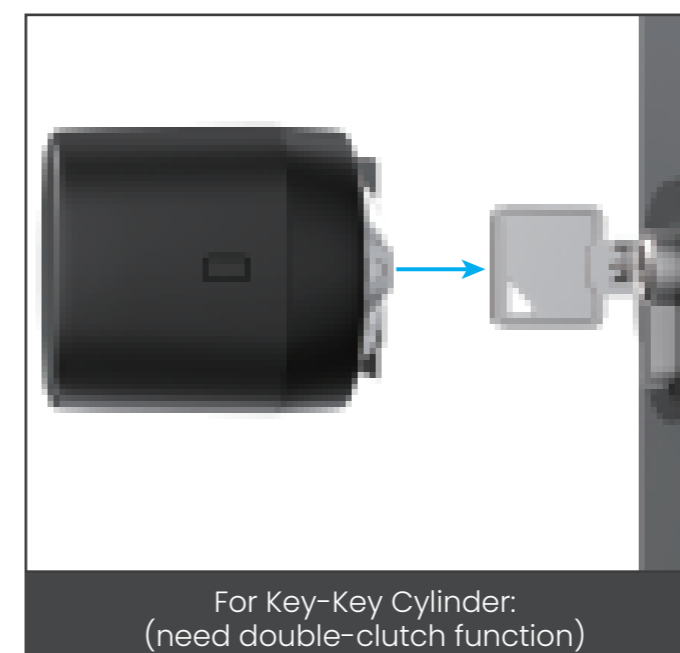
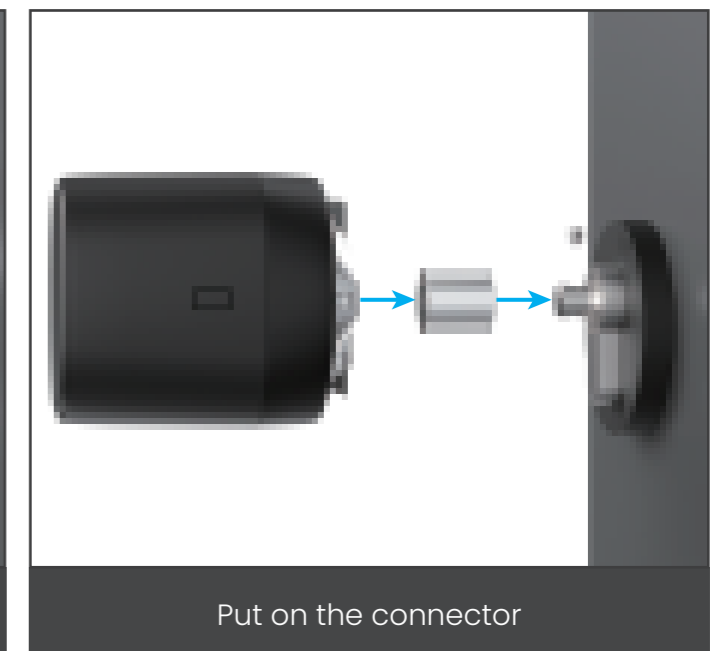
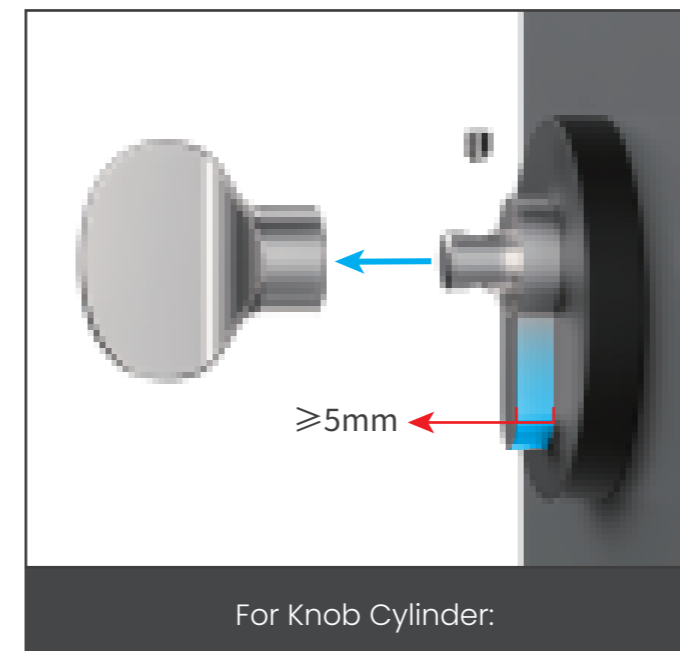
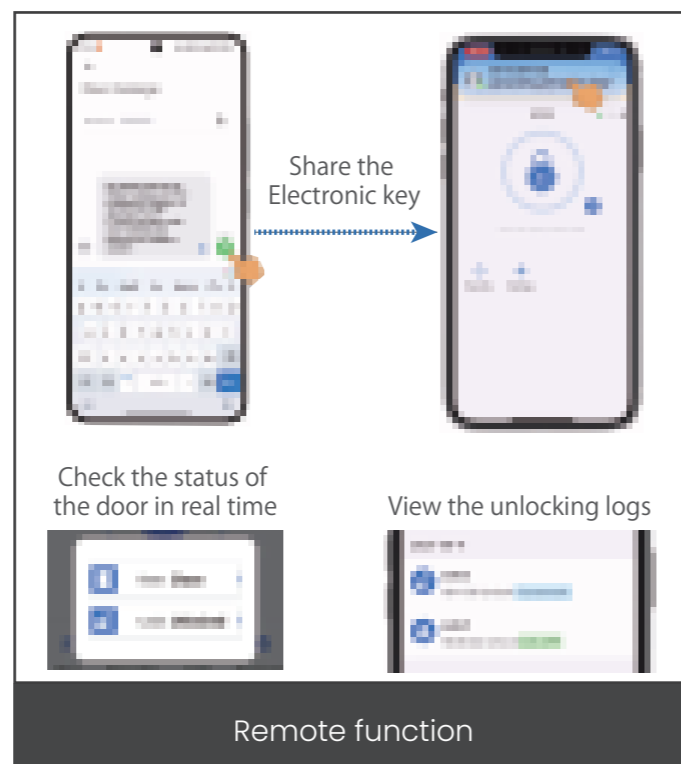
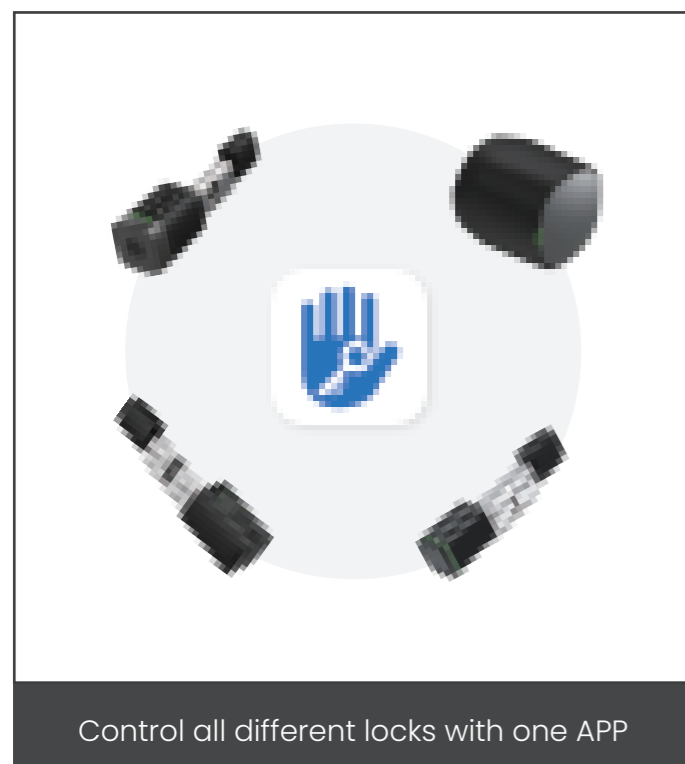
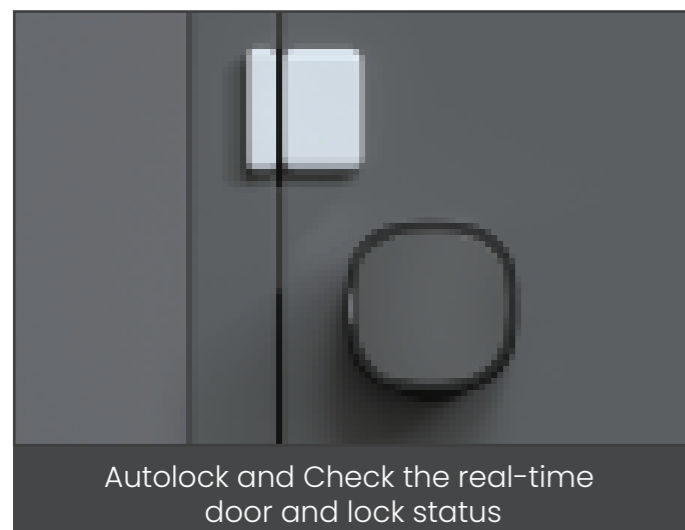

D2-M



RETROFIT MOTORIZED SMART LOCKS MODULAR CYLINDER

Retrofit side



Cylinder side
out door

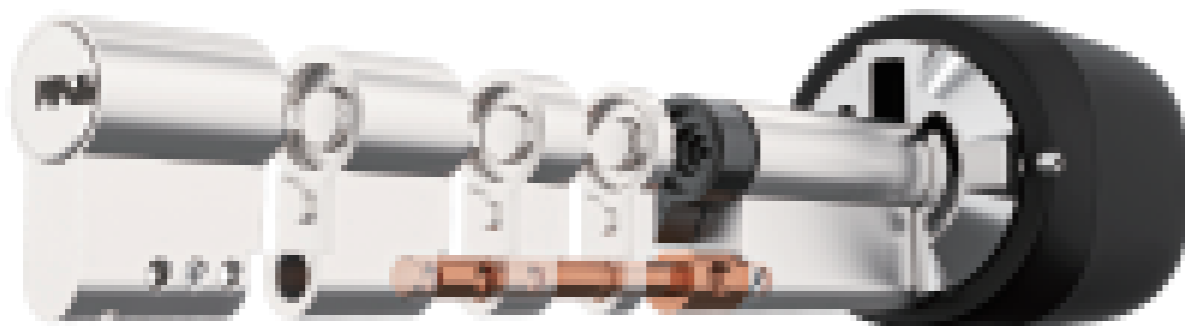

Retrofit side
in door

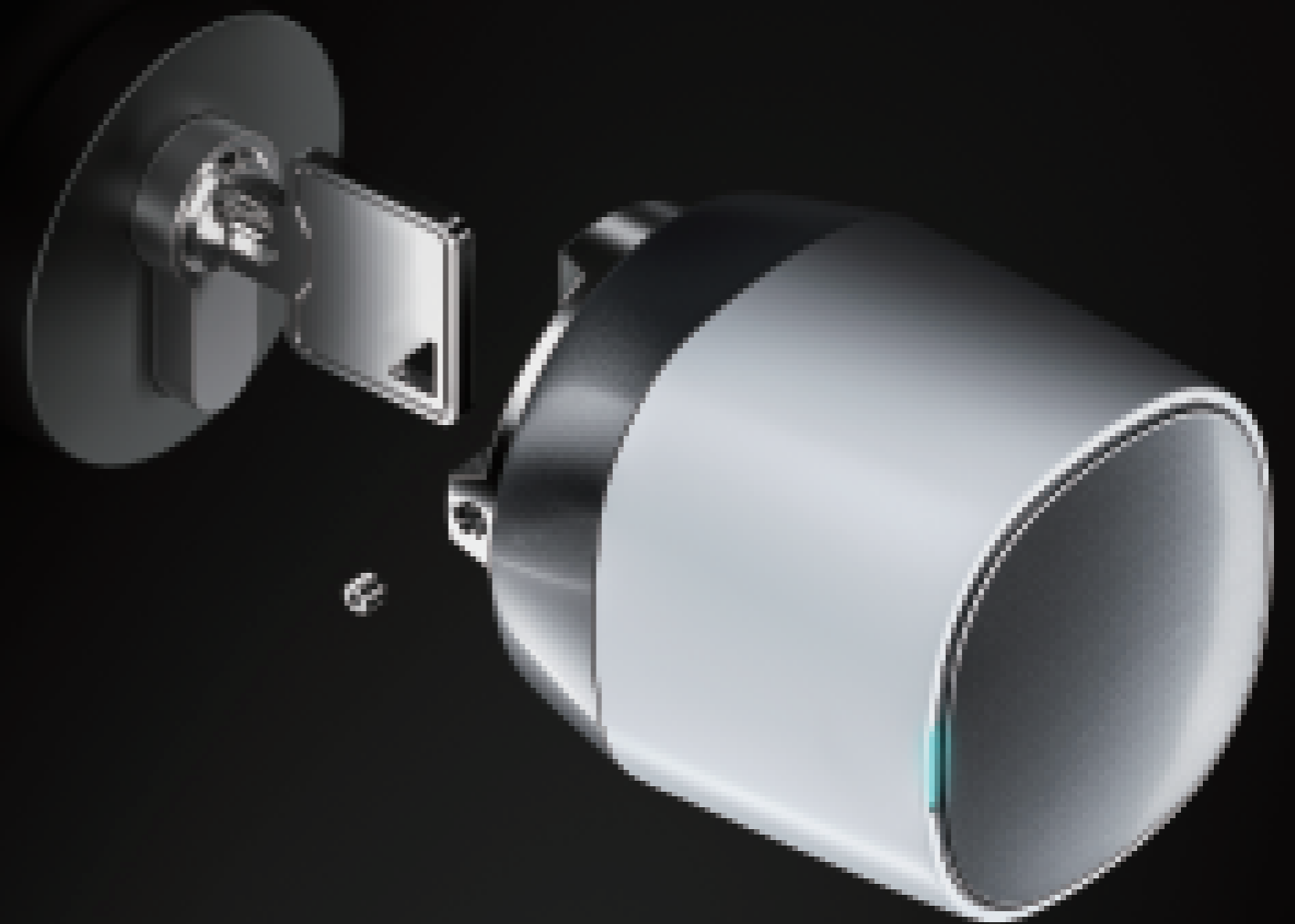



ELECTRONIC SMART LOCK CYLINDER

- Modular function: easily changes the cylinder length.
- TUYA/TTLOCK apps remote unlock (through Gateway), BLE distance unlock, Passwords unlock, RFID card/NFC unlock, Mechanical key unlock.
- Card type: MIFARE Classic® S50 card, 13.56Mhz. ISO1443A.
- Access management for private, commercial, office, hotel and apartment.
- (Recommend TTLOCK Application)
CE, FCC, RoHS, EN15684 certified.
- IP55 Waterproof. Working temperature: -25 degree to 70 degree.
- Back-up type-C power supply.
- 3 pcs of Number 7 (AAA) battery and 1-year battery life.
- OEM and ODM service available, Including offering APP SDK file and API.

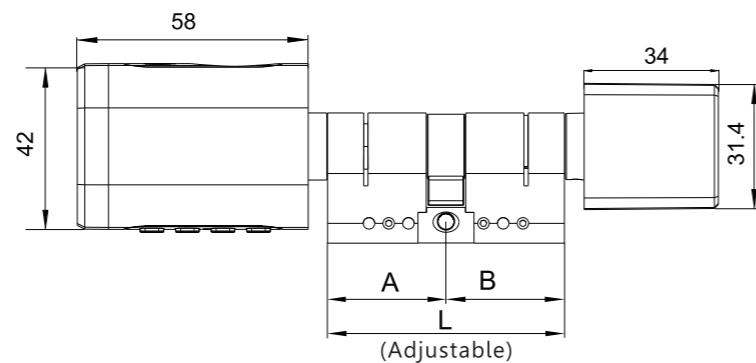

TTLock



TUYA



WiFi Gateway



Card Encoder

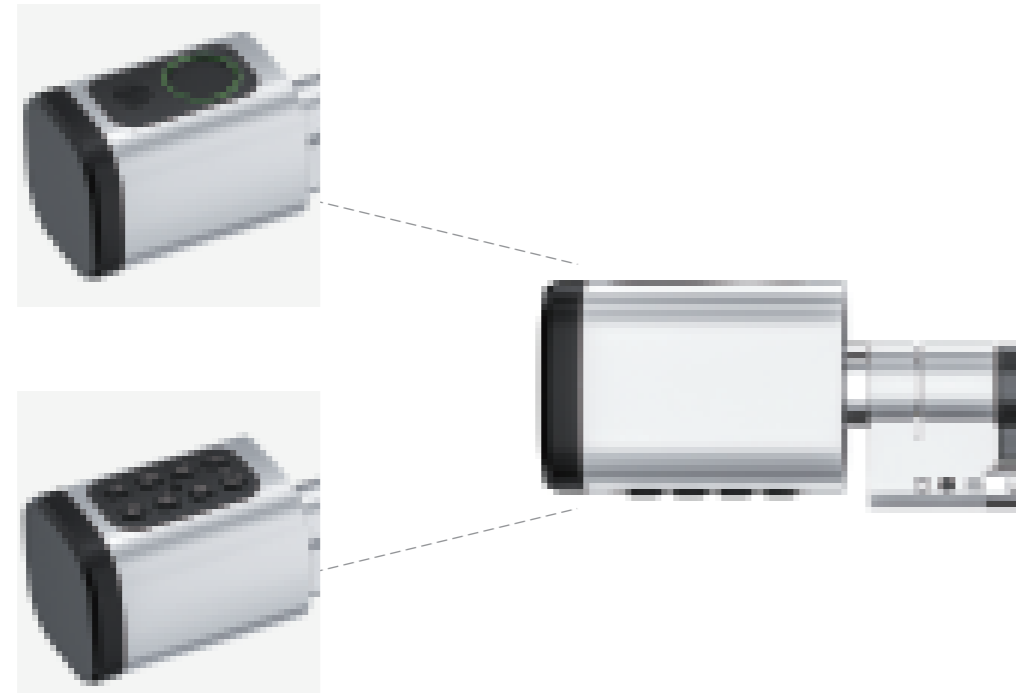

**Fingerprint / RFID card / Keypad
All-in-One Knob**

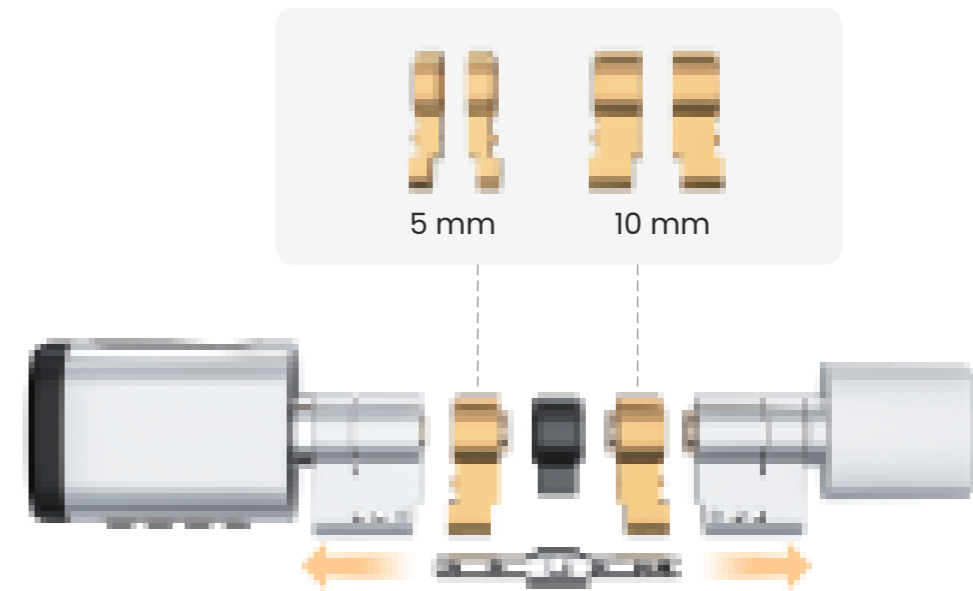

Easy Adjustable Length

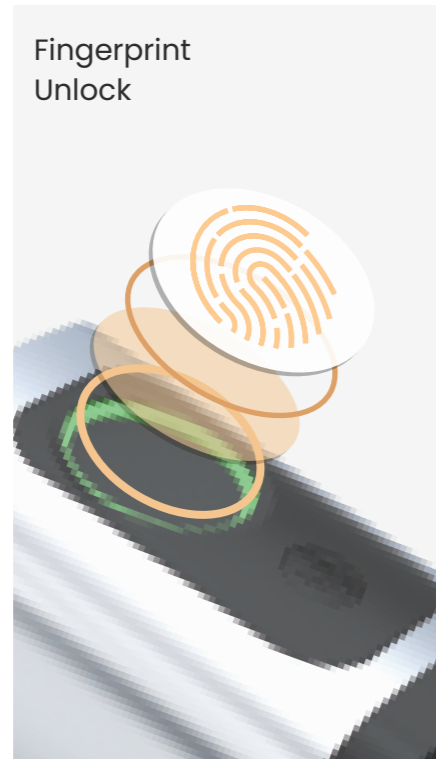
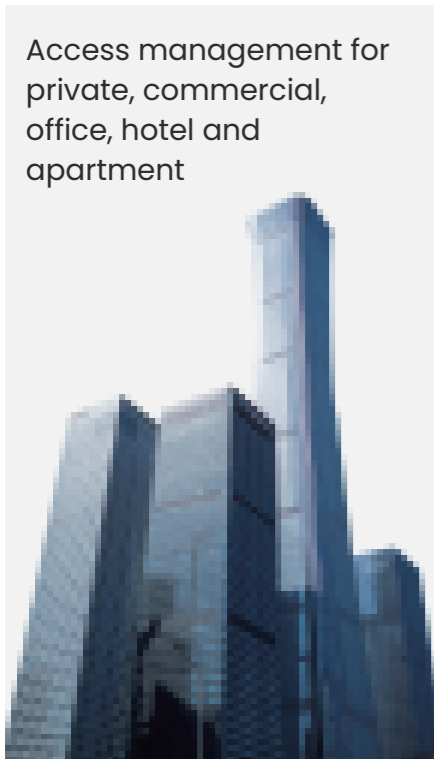

OTHER TYPES OF D1

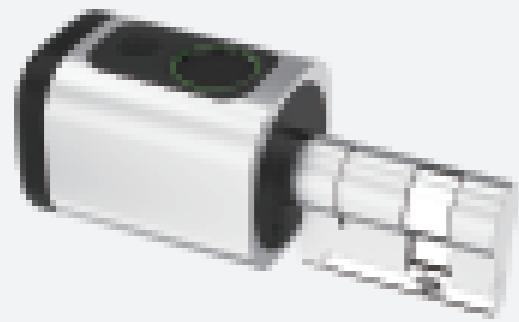

Half Cylinder

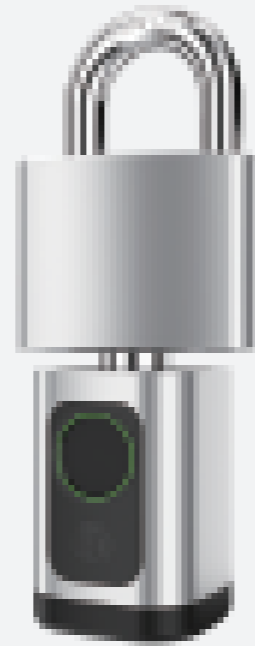

Padlock



Scandinavian Oval Cylinder



Australian Oval Cylinder

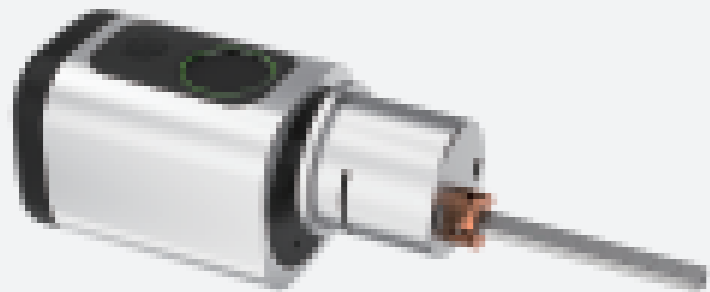

Rim Cylinder



Mortise Cylinder

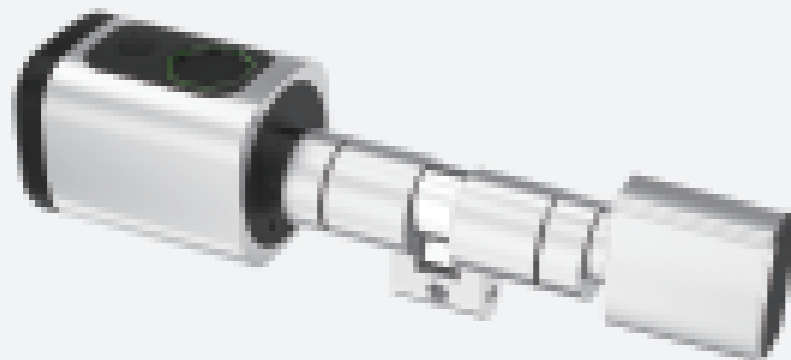

Swiss Profile Cylinder

SMART LOCK CYLINDERS

- Modular function: easily changes the cylinder length.
- TUYA/TTLOCK apps remote unlock (through Gateway), BLE distance unlock, Passwords unlock, RFID card/NFC unlock, Mechanical key unlock.
- Pin tumbler mechanical back-up lock cylinder, able to fabricate the MK system.
- Card type: MIFARE Classic® S50 card, 13.56Mhz. ISO14443A.
- Access management for private, commercial, office, hotel and apartment. (Recommend TTLOCK Application)
- CE, FCC, RoHS, EN15684 certified.
- IP66 Waterproof. Working temperature: -25 degree to 70 degree.
- Back-up type-C power supply.
- 4 pcs of Number 7 (AAA) battery and 1-year battery life.
- OEM and ODM service available, including offering APP SDK file and API.

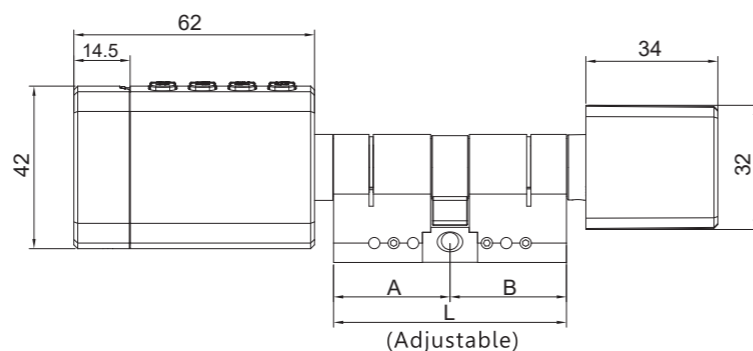
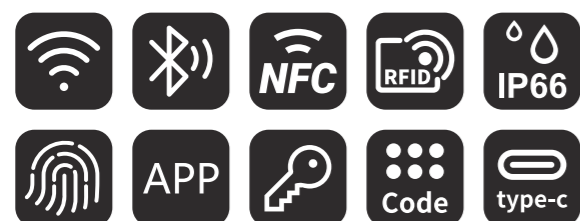

TTLock



TUYA



WiFi Gateway



Card Encoder



Emergency key

Mechanical Key
Able to create the MK/KA system

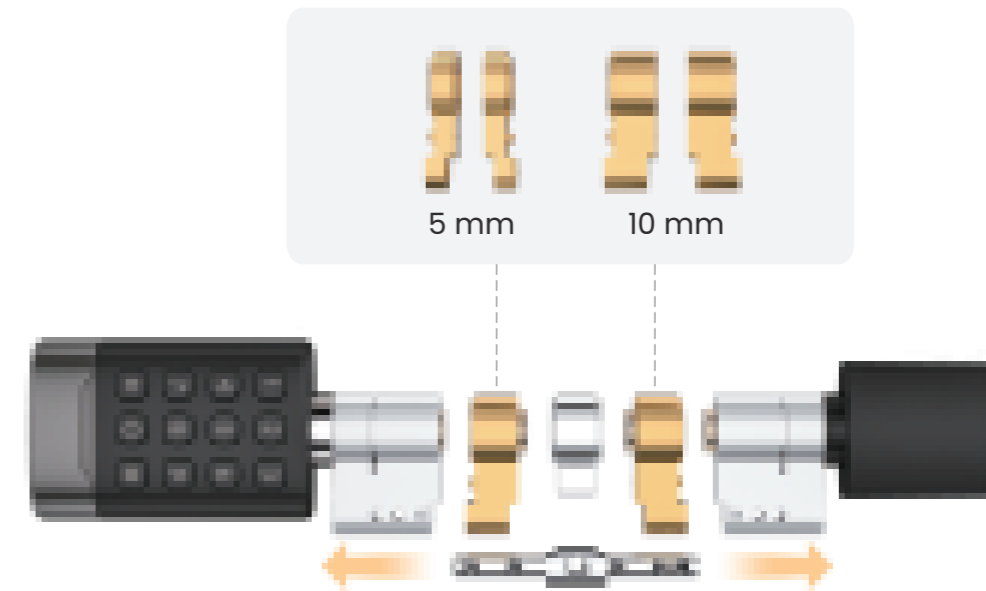

Easy Adjustable Length

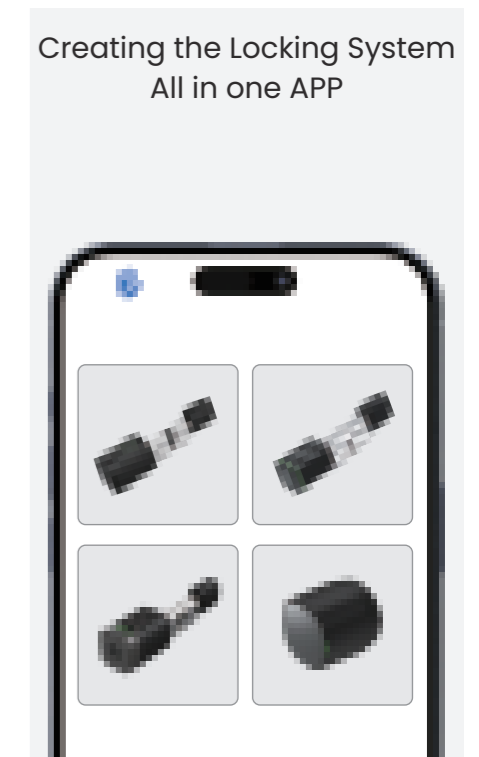
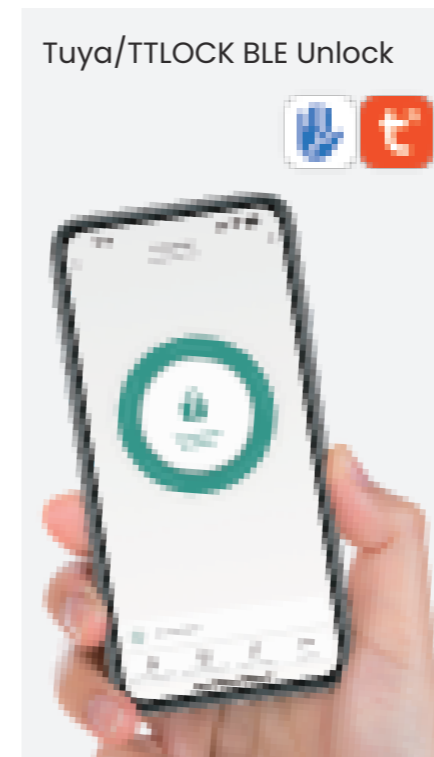
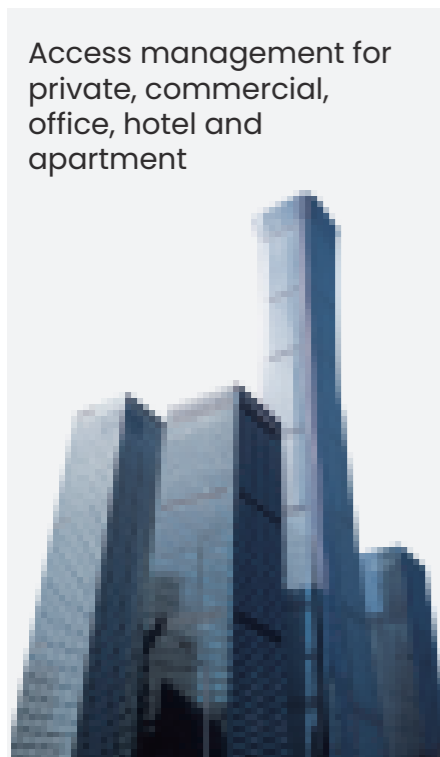

OTHER TYPES OF D1 PLUS

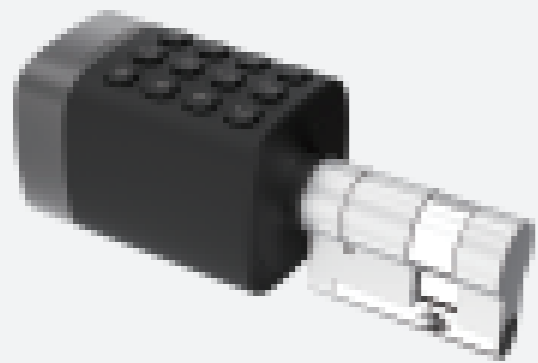

Half Cylinder

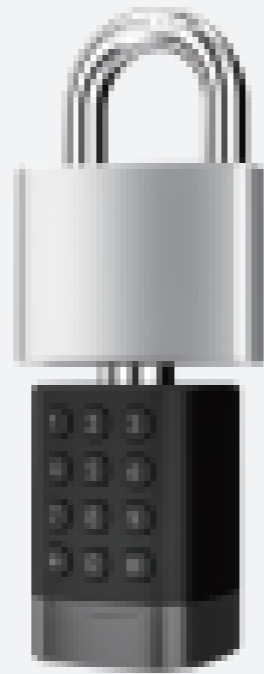

Padlock



Scandinavian Oval Cylinder



Australian Oval Cylinder

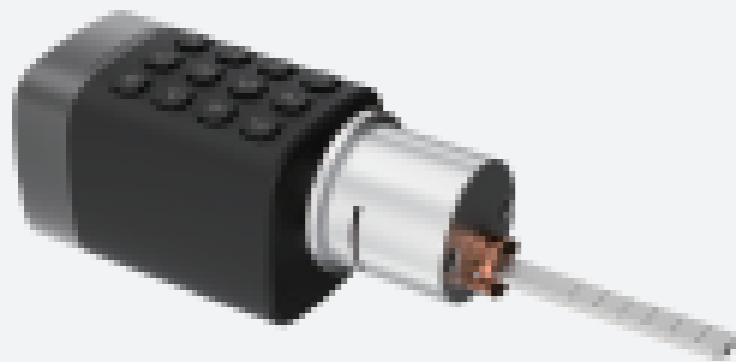

Rim Cylinder



Mortise Cylinder

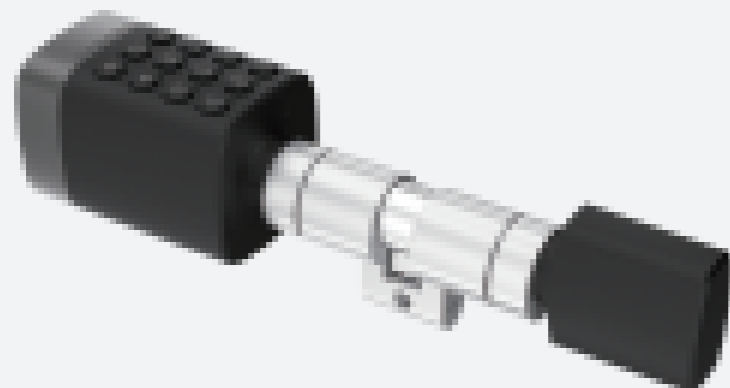

Swiss Profile Cylinder



SMART LOCK CYLINDERS

- Modular function: easily changes the cylinder length.
- TUYA/TTLOCK apps remote unlock (through Gateway), BLE distance unlock, RFID Card/NFC unlock.
- Card type: MIFARE Classic® S50 card, 13.56Mhz. ISO14443A.
- Optional card type: MIFARE DESFire® card.
- Access management for private, commercial, office, hotel and apartment.
(Recommend TTLOCK Application)
- CE, FCC, RoHS, Fire rated 100Hrs, IP68 certified.
- IP68 Waterproof. Working temperature: -25 degree to 70 degree.
- 1 pcs of 3V CR14250 battery and 1-year battery life.
- Other Accessories:
Keypad: with fingerprint, and pin code.
Card encoder
- OEM and ODM service available, Including offering APP SDK file and API.

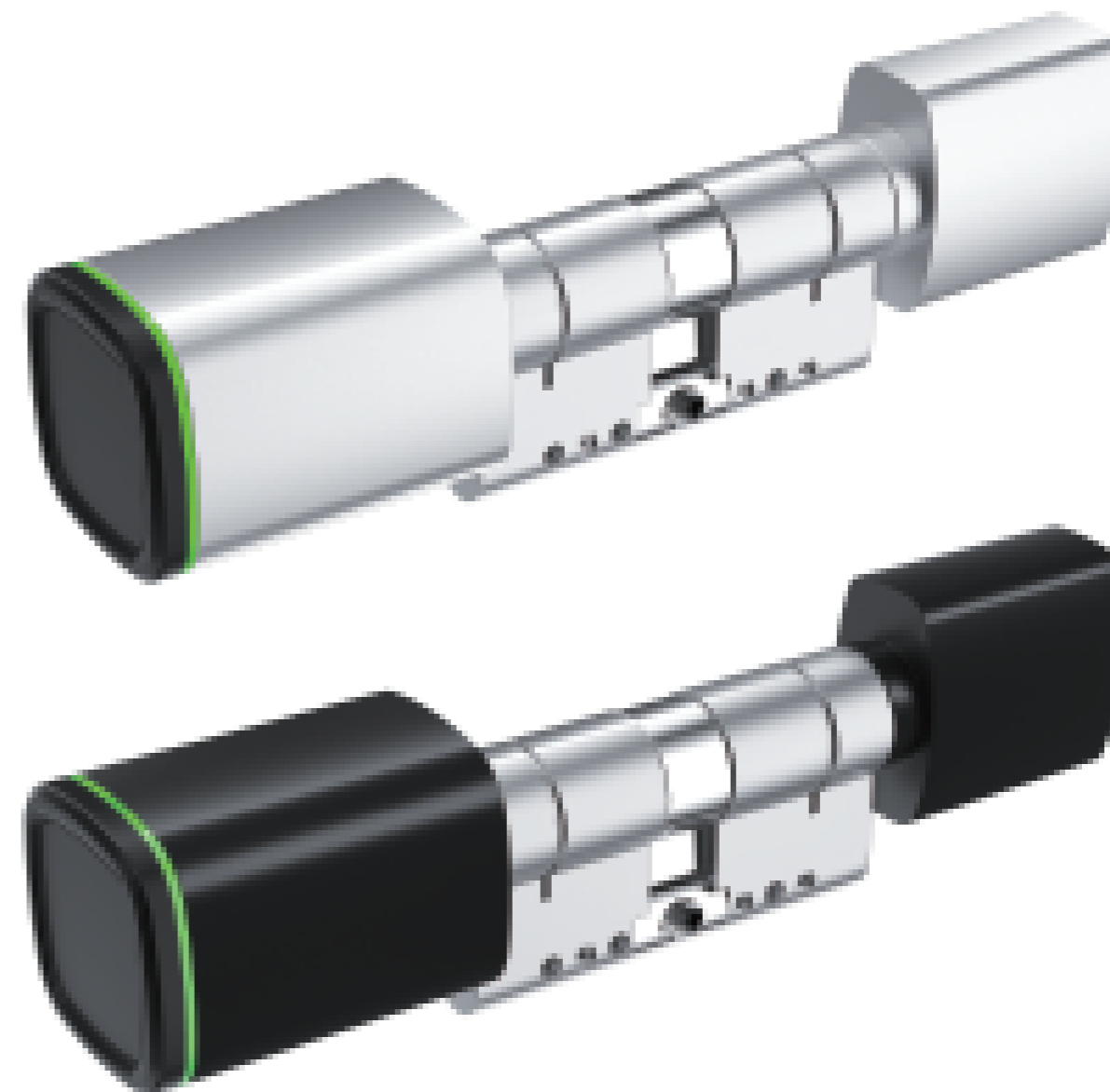
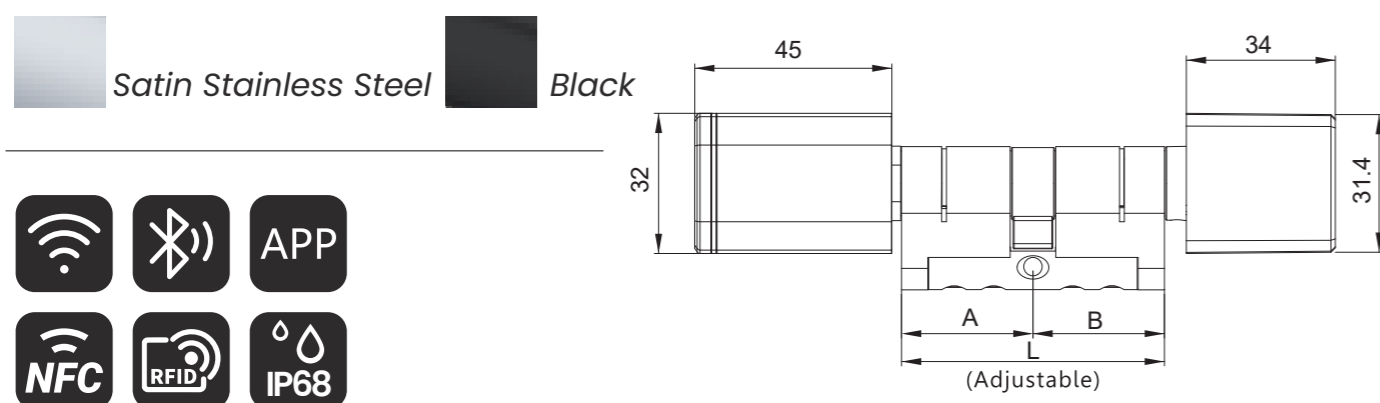

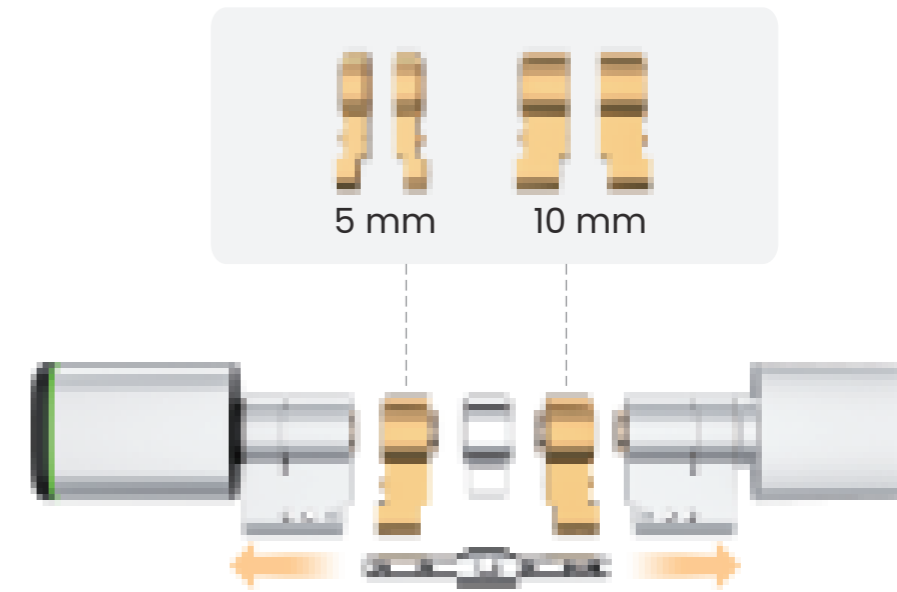

Access management for private, commercial, office, hotel and apartment.



RFID Card Unlock



NFC Unlock



Tuya / TTLock Unlock



OTHER TYPES OF D3

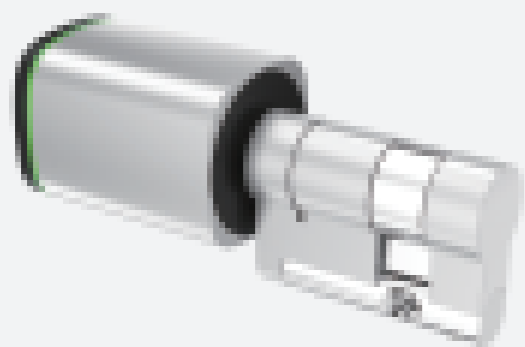

Half Cylinder



Padlock

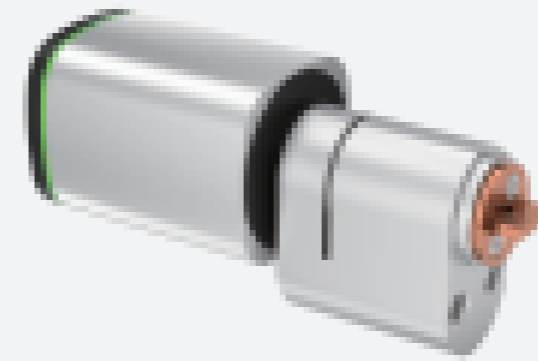

Scandinavian Oval Cylinder

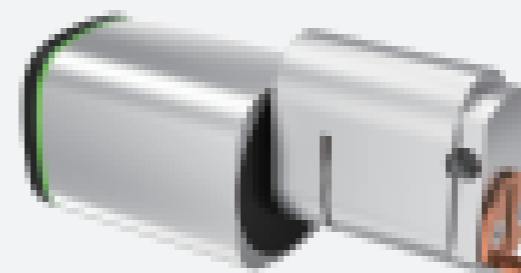

Australian Oval Cylinder

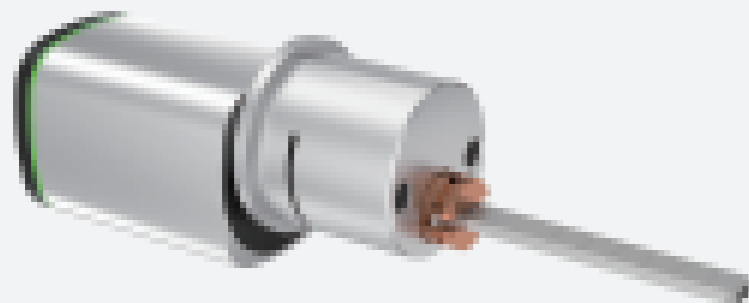

Rim Cylinder

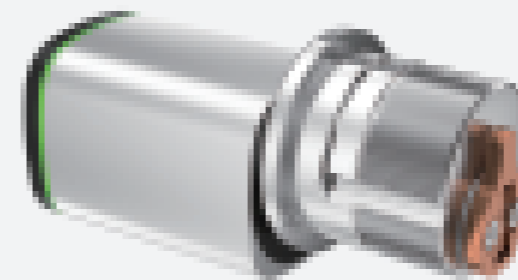

Mortise Cylinder

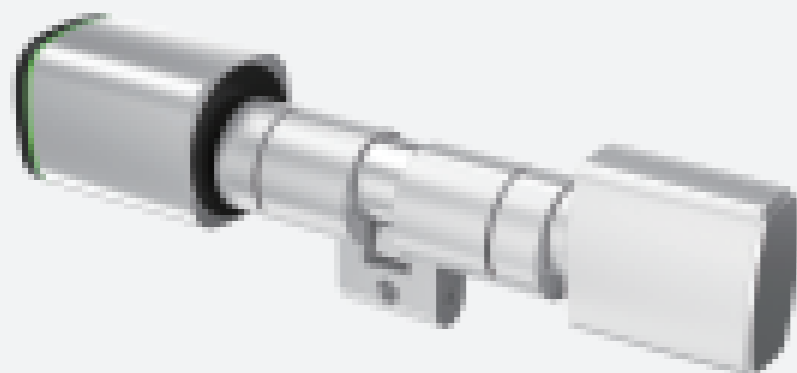

Swiss Profile Cylinder

K1

SMART HANDLE SET

- Material: Stainless Steel 304 handle and panel.
- Finish: SSS or Black or Gold.
- Unlock Methods: TUYA/TTLOCK apps remote unlock(through Gateway), BLE distance unlock, Fingerprint unlock, Passwords unlock, RFID card/NFC, Emergency mechanical key.
- Application: Access management for private, commercial, office, hotel and apartment.
- Certification: CE, FCC, RoHS.
- IP Rating: IP64 waterproof.
- Battery: 4x AAA alkaline batteries (DC 6V).
- Back-Up Type-C Unlock: Available.
- Door thickness: 30-90mm.
- Panel size: 303mm length, 43mm width, 22.5mm height.
- Support mortise: 85mm center distance mortise.
- Support door type: wooden and aluminum doors.
- Service: OEM and ODM service available, including offering APP SDK file and API.

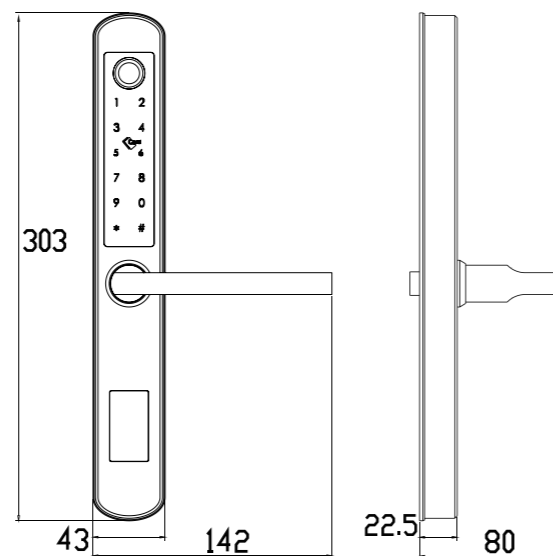
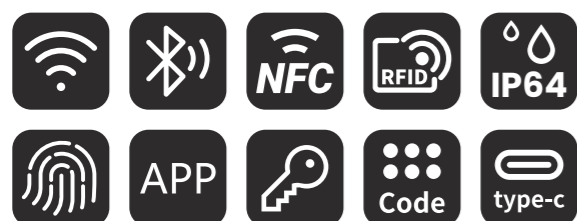
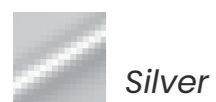

TTLock



TUYA



WiFi Gateway

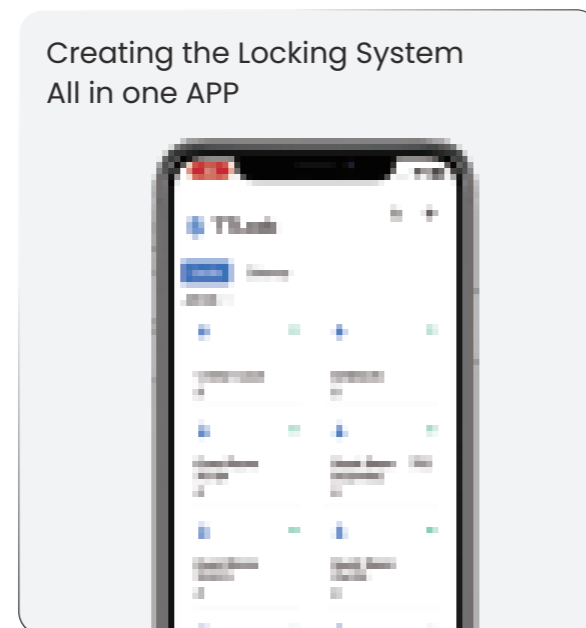
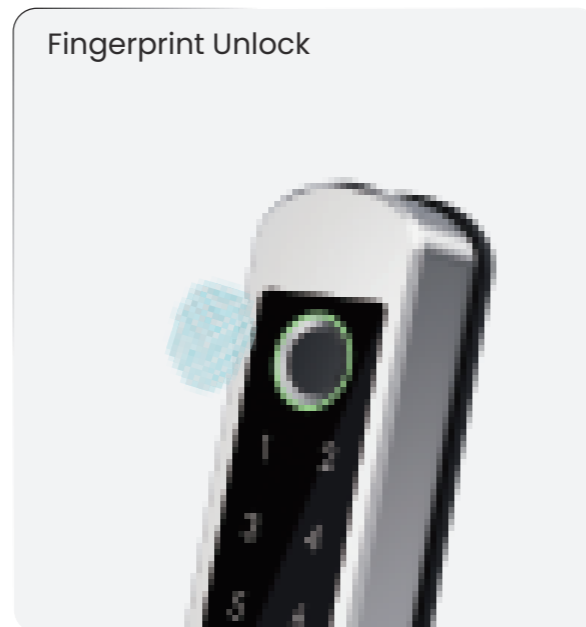
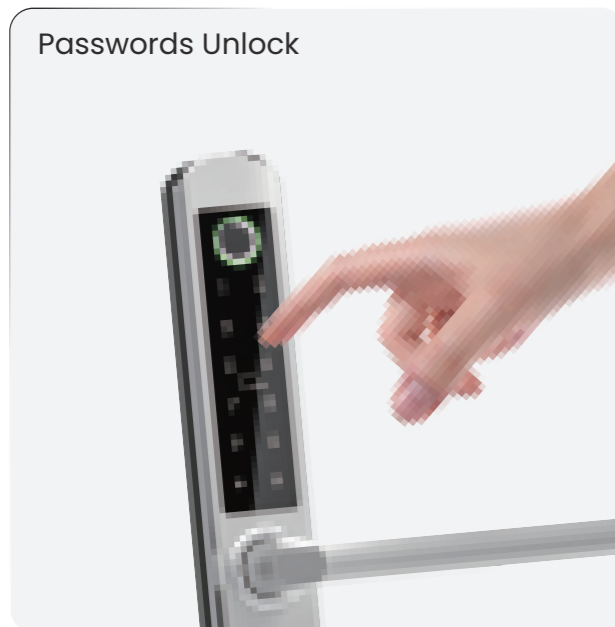

Access management for private, commercial, office, hotel and apartment.





SMART HANDLE SET

- Material: Stainless Steel 304 handle and panel.
- Finish: SSS or Black or Gold.
- Unlock Methods: TUYA/TTLOCK apps remote unlock(through Gateway), BLE distance unlock, Fingerprint unlock, Passwords unlock, RFID card/NFC, Emergency mechanical key.
- Application: Access management for private, commercial, office, hotel and apartment.
- Certification: CE, FCC, RoHS.
- IP Rating: IP65 waterproof.
- Battery: 4x AAA alkaline batteries (DC 6V).
- Back-Up Type-C Unlock: Available.
- Door thickness: 30-90mm.
- Panel size: 303mm length, 43mm width, 22.5mm height.
- Support mortise: 72mm, 85mm, 90mm center distance mortise.
- Support door type: wooden and aluminum doors.
- Service: OEM and ODM service available, including offering APP SDK file and API.

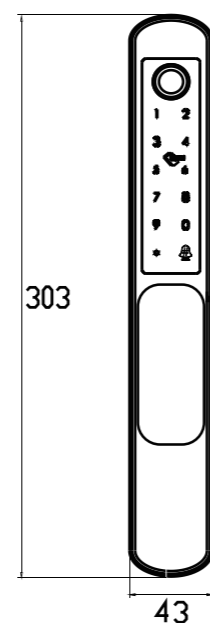

TTLock



TUYA



WiFi Gateway

IP65
WATERPROOF DESIGN

Working temperature:
-25 degrees to 70 degrees.



CORE PRODUCT PORTFOLIO



Access management for private, commercial, office, hotel and apartment.



Tuya / TTLock Unlock

We partner with leading smart lock platforms to ensure reliable connectivity, rich features, and long-term ecosystem support for home users.

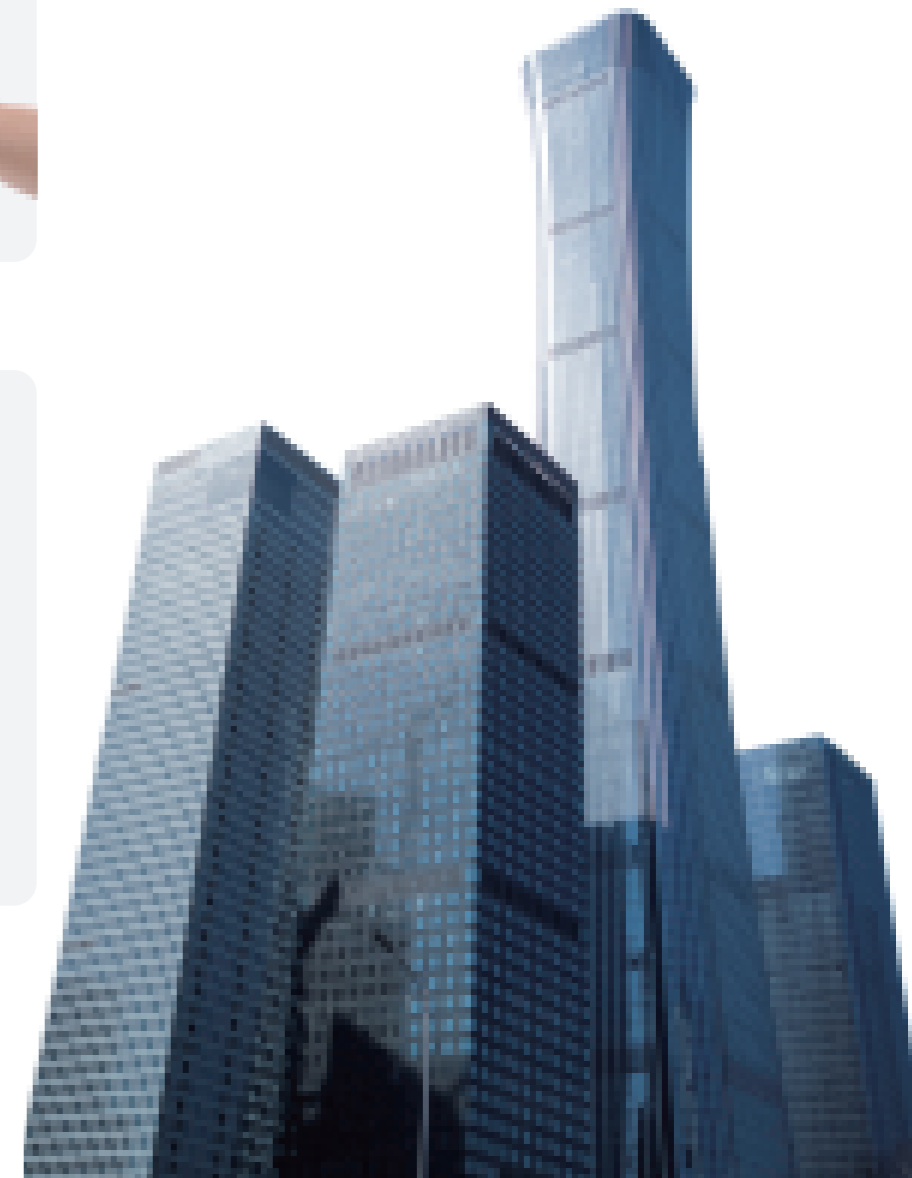
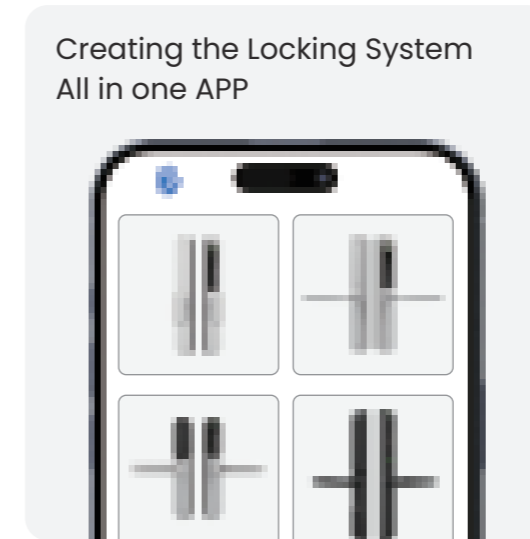
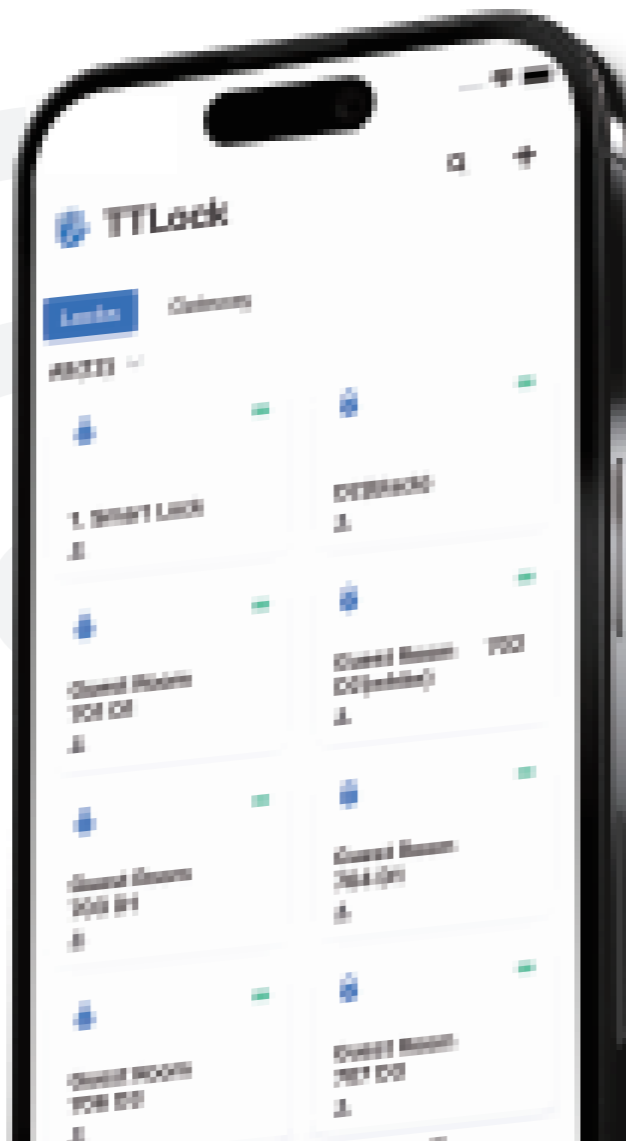



SMART HANDLE SET

- Material: Stainless Steel 304 handle and panel.
- Finish: SSS or Black or Gold.
- Unlock Methods: TUYA/TTLOCK apps remote unlock(through Gateway), BLE distance unlock, Fingerprint unlock, Passwords unlock, RFID card/NFC, Emergency mechanical key.
- Application: Access management for private, commercial, office, hotel and apartment.
- Certification: CE, FCC, RoHS, Fire rated certified.
- IP Rating: IP65 waterproof.
- Battery: 4xAAA alkaline batteries (DC 6V).
- Back-Up Type-C Unlock: Available.
- Door thickness: 40-90mm.
- Panel size: 283.5mm length, 53.5mm width, 22.5mm height.
- Support mortise: 72mm, 85mm, 90mm center distance mortise.
- Support door type: wooden and aluminum doors.
- Service: OEM and ODM service available, including offering APP SDK file and API.

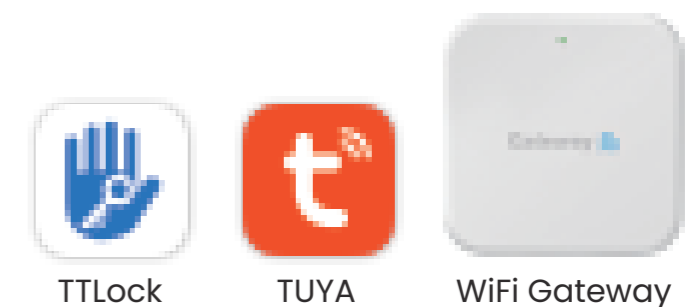
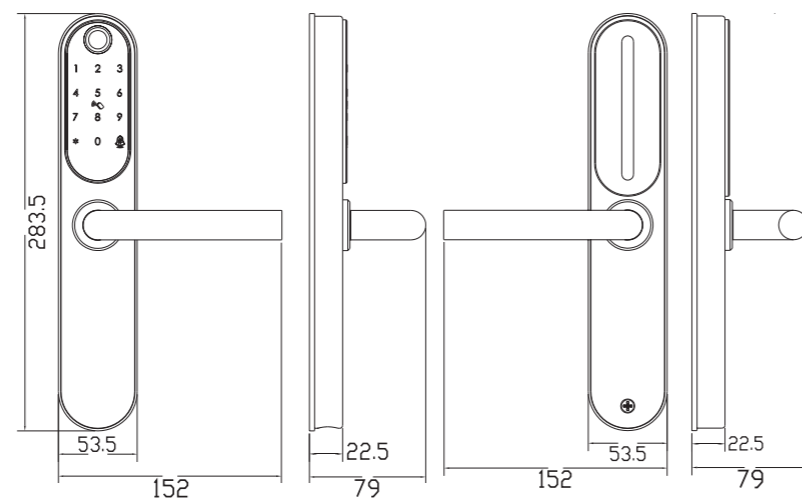
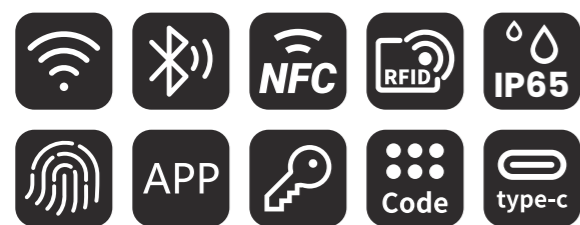
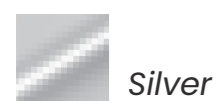

IP65

Working temperature:
-25 degrees to 70 degrees.



Fire-Resistant & Safe

Safety-first design with fire-resistant materials and automatic unlocking during emergencies, meeting international safety standards.

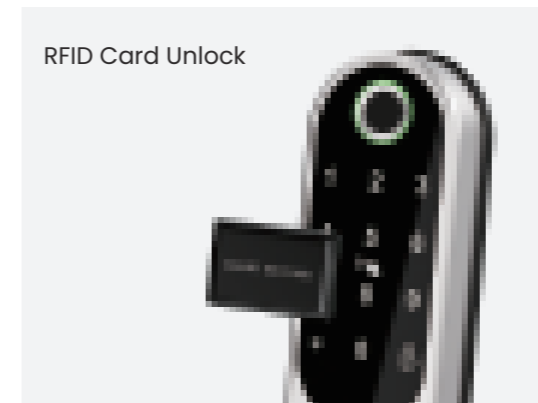

RFID Card Unlock

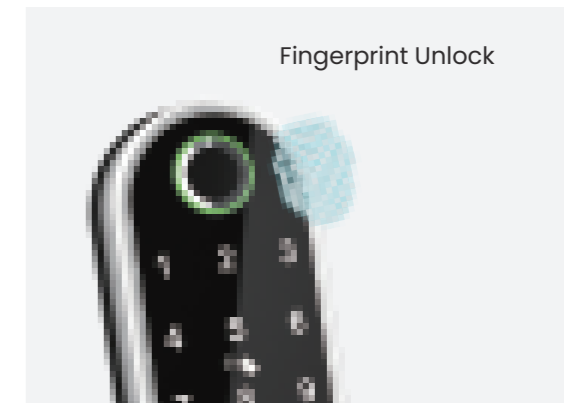

Fingerprint Unlock

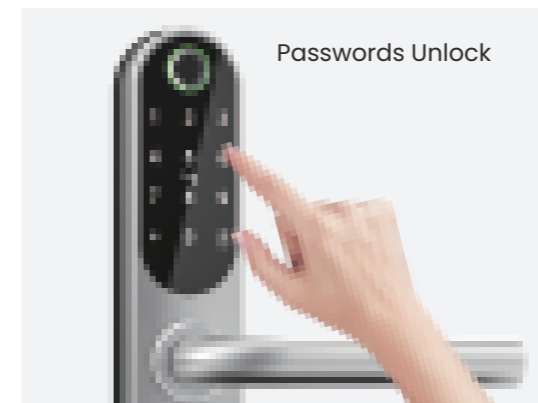

Passwords Unlock

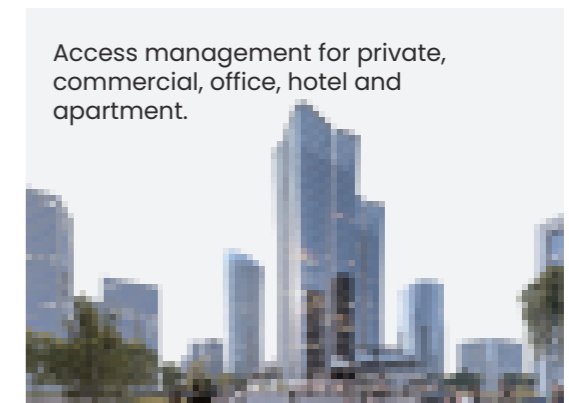

Access management for private, commercial, office, hotel and apartment.

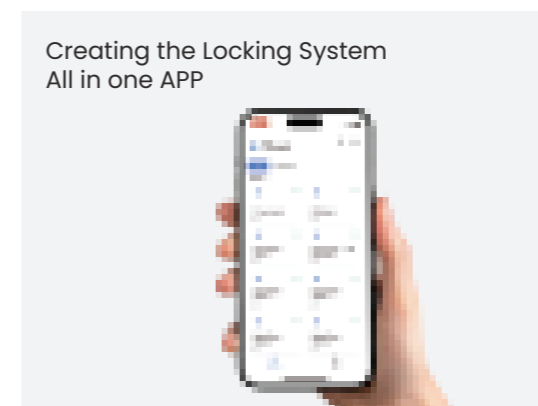

Creating the Locking System
All in one APP

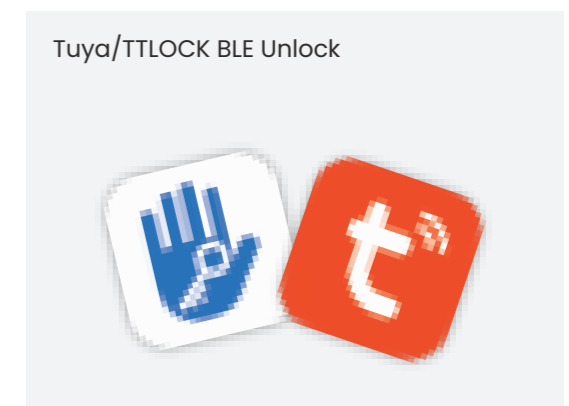

Tuya/TTLOCK BLE Unlock



SMART HANDLE SET

- Material: Aluminum alloy.
- Finish: Silver or Black or Grey.
- Unlock Methods: TUYA/TTLOCK apps remote unlock(through Gateway), BLE distance unlock, Fingerprint unlock, Passwords unlock, RFID card/NFC, Emergency mechanical key.
- Application: Access management for private, commercial, office, hotel and apartment.
- Certification: CE, FCC, RoHS.
- IP Rating: IP65 waterproof.
- Battery: 4xAAA alkaline batteries (DC 6V).
- Back-Up Type-C Unlock: Available.
- Door thickness: 30-90mm.
- Panel size: 328mm length, 35mm width, 22.5mm height.
- Support mortise: 72mm, 85mm, 90mm center distance mortise.
- Support door type: steel and aluminum doors.
- Service: OEM and ODM service available, including offering APP SDK file and API.

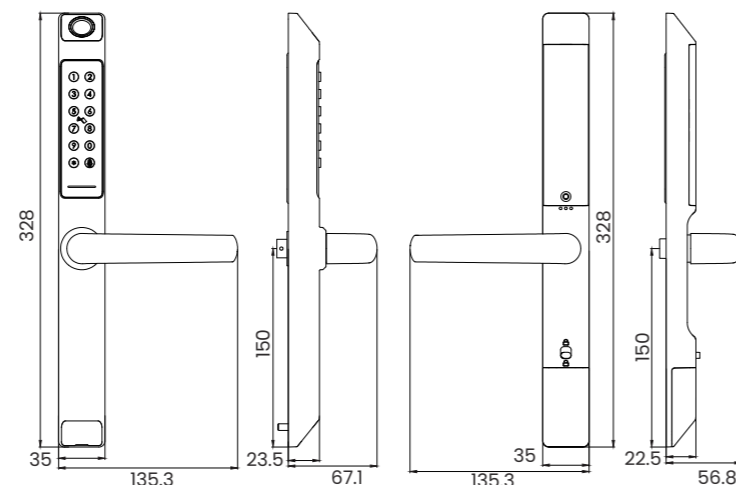

TTLock



TUYA



WiFi Gateway



■ **Quality Control You Can Rely On**

A strict, multi-layer quality control system designed to ensure long-term reliability, production consistency, and the highest standards across every product we deliver.





SMART HANDLE SET

- Material: Stainless Steel 304 handle and panel.
- Finish: SSS or Black.
- Unlock Methods: TUYA/TTLOCK apps remote unlock(through Gateway), BLE distance unlock, Fingerprint unlock, Passwords unlock, RFID card/NFC, Emergency mechanical key.
- Application: Access management for private, commercial, office, hotel and apartment.
- Certification: CE, FCC, RoHS, UL and Fire rated certified.
- Battery: 4x AA alkaline batteries.
- Back-Up Type-C Unlock: Available.
- Door thickness: 40-90mm.
- Panel size: 283.5mm length, 53.5mm width, 22.5mm height.
- Support mortise: American standard mortise.
- Support door type: wooden and aluminum doors.
- Service: OEM and ODM service available, including offering APP SDK file and API.

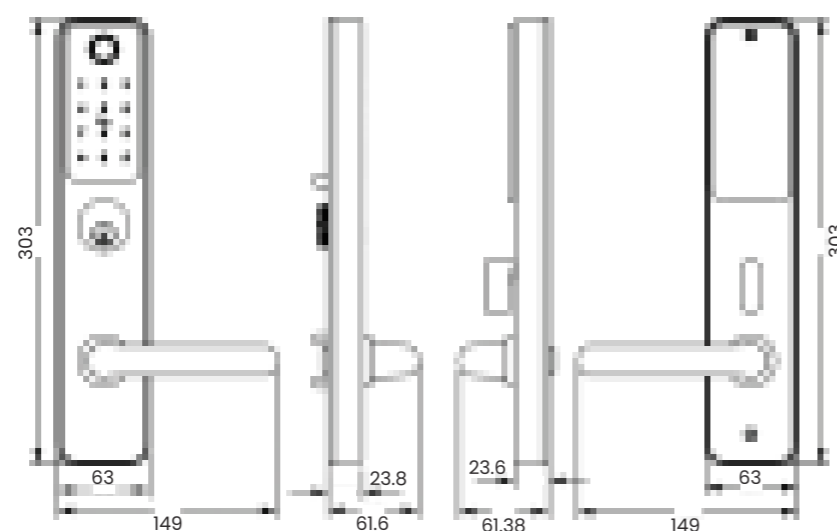
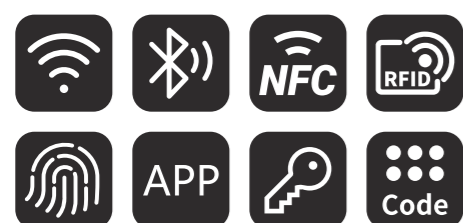
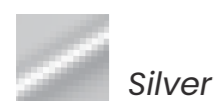

TTLock



TUYA



WiFi Gateway

FINGERPRINT LOCK ANSI STANDARD

CORE PRODUCT PORTFOLIO

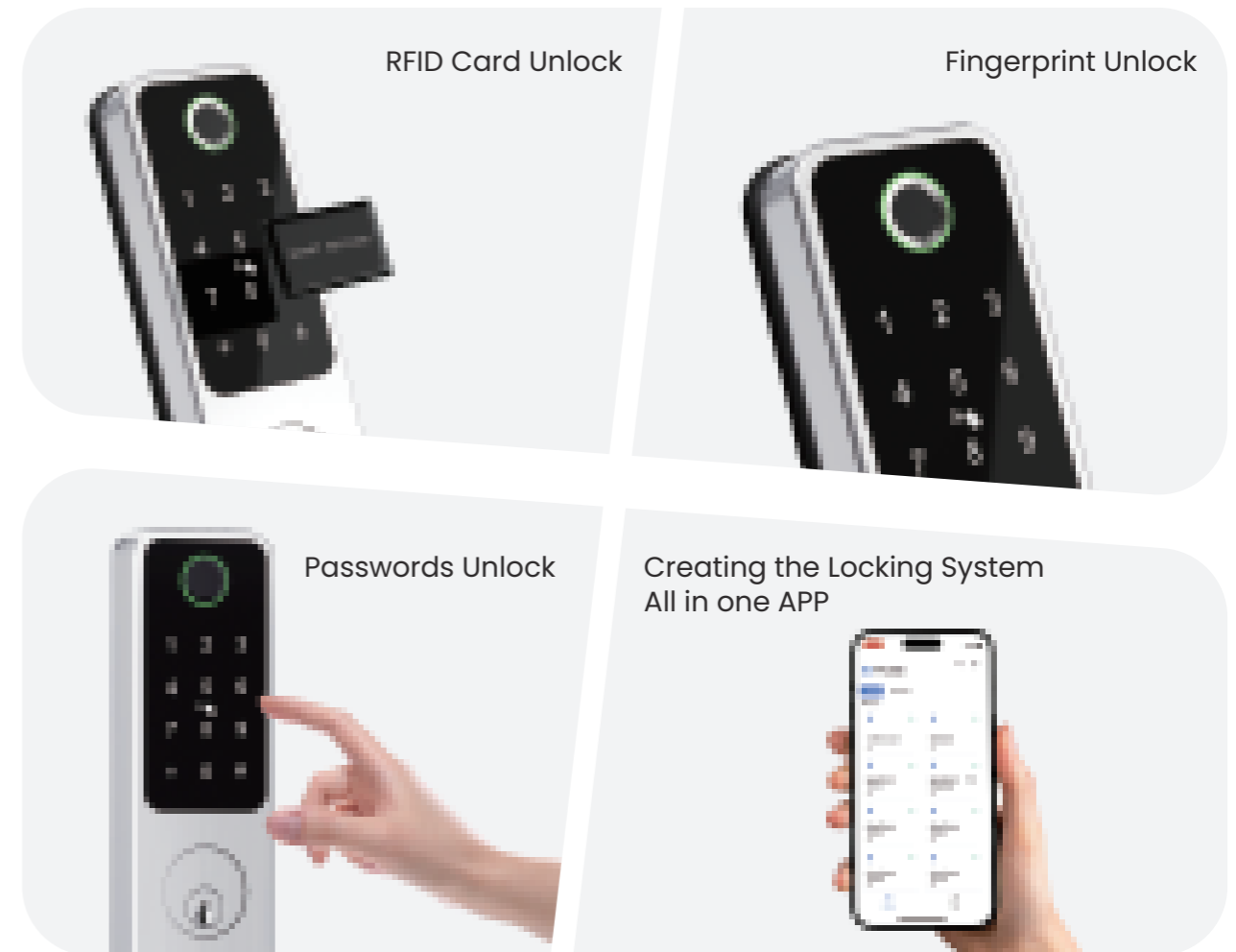

Access management for private, commercial, office, hotel and apartment.





SMART HANDLE SET

- Material: Stainless Steel 304 handle and panel
- Finish: SSS or Black
- Unlock Methods: TUYA/TTLOCK apps remote unlock(through Gateway), BLE distance unlock, Fingerprint unlock, Passwords unlock, RFID card/NFC, Emergency mechanical key.
- Application: Access management for private, commercial, office, hotel and apartment.
- Certification: CE, FCC, RoHS.
- IP Rating: IP65 waterproof
- Battery: 4x AAA alkaline batteries.
- Back-Up Type-C Unlock: Available
- Door thickness: 40-90mm
- Panel size: 283.5mm length, 53.5mm width, 22.5mm height.
- Support mortise: Australian standard mortise.
- Support door type: wooden and aluminum doors.
- Service: OEM and ODM service available, including offering APP SDK file and API.

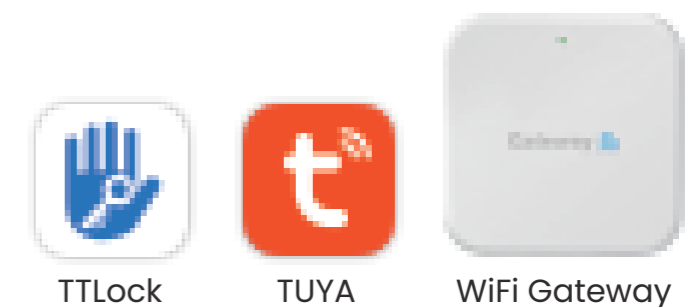
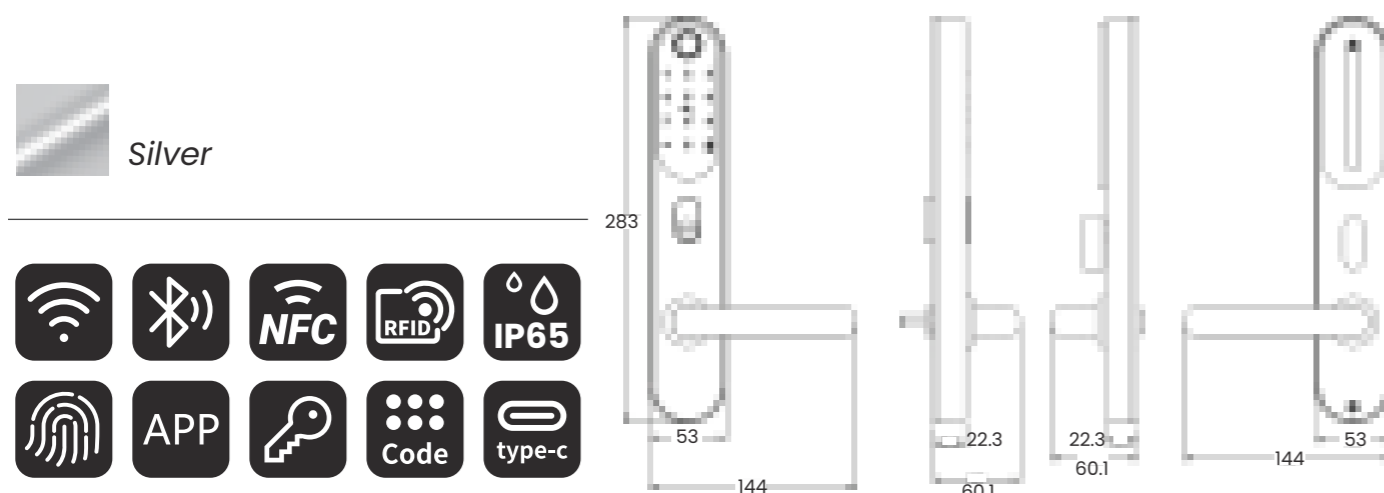



RFID Card Unlock



Passwords Unlock



Fingerprint Unlock

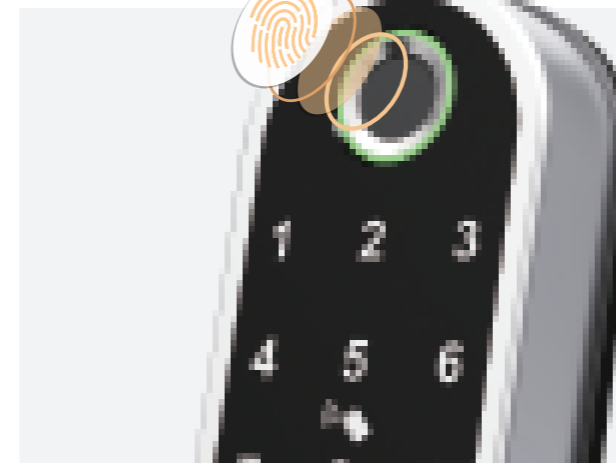

Back-Up Type-C Unlock



Access management for private, commercial, office, hotel and apartment



Creating the Locking System All in one APP

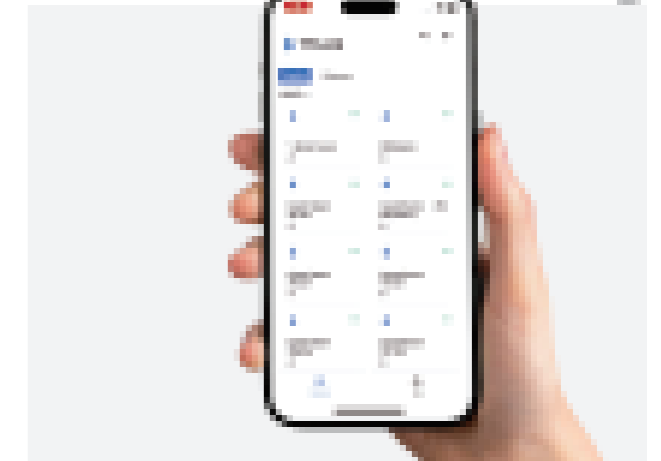



SMART LEVER HANDLE LOCK

- Material: Aluminum alloy, PC and Acrylic.
- Finish: Silver or Black.
- Unlock Methods: TUYA/TTLOCK apps remote unlock(through Gateway), BLE distance unlock, Fingerprint unlock, Passwords unlock, Emergency mechanical key.
- Application: Access management for private, commercial, office, hotel and apartment.
- Certification: CE, FCC, RoHS.
- Battery: 4xAAA alkaline batteries.
- Back-Up Type-C Unlock: Available.
- Door thickness: 35-55mm.
- Size: 147mm handle length, diameter 71mm rosette.
- Support mortise/latch: European mortise and American adjustable latch.
- Support door type: wooden and metal doors.
- Service: OEM and ODM service available, Including offering APP SDK file and API.

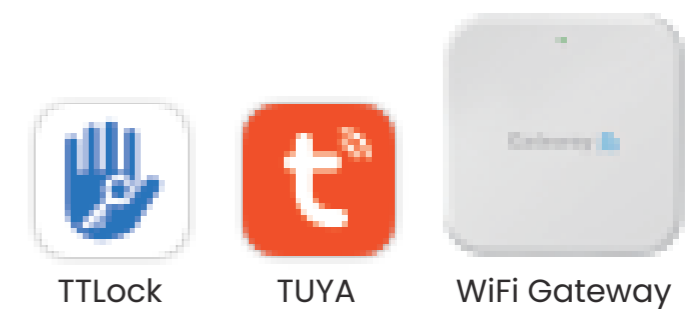
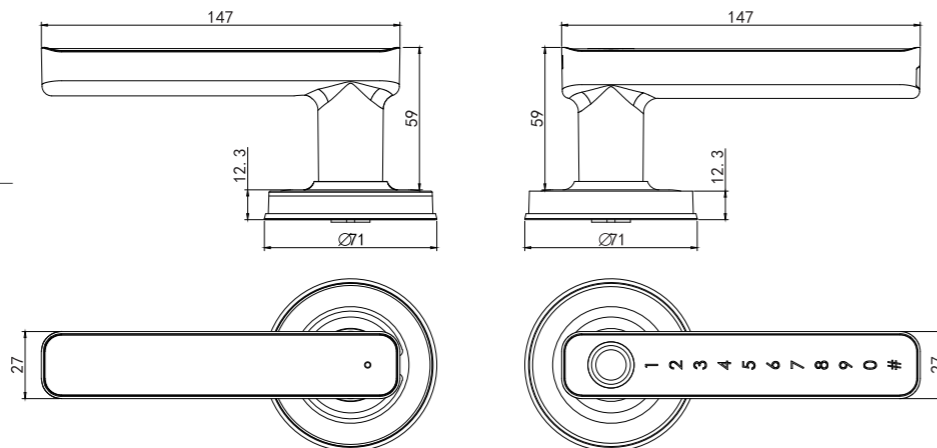
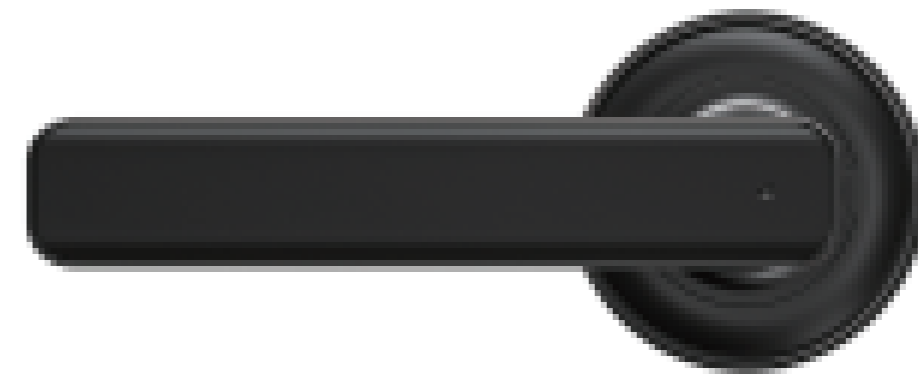

QUALITY CONTROL YOU CAN RELY ON

TECHNOLOGY CHANGES THE LIFE



Back-Up Type-C Unlock.



Emergency mechanical key.



Fingerprint Unlock



Passwords Unlock

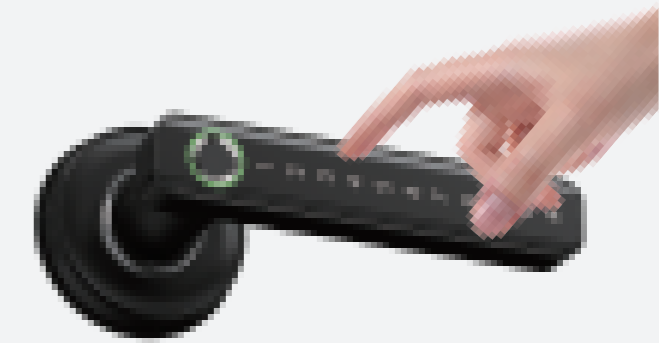

Creating the Locking System
All in one APP

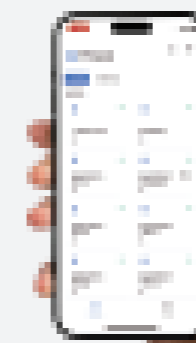

Tuya/TTLOCK BLE Unlock

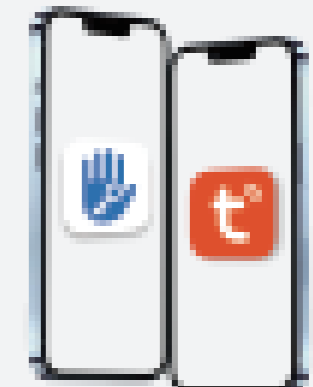



SMART KEY BOX

- Material: Aluminum Alloy.
- Finish: Black or White.
- Unlock Methods: TUYA/TTLOCK apps, BLE distance unlock, Fingerprint unlock, Passwords unlock, RFID card/NFC, Emergency mechanical key.
- Application: B&B, home use.
- Certification: CE, FCC, RoHS.
- IP Rating: IP65 waterproof.
- Battery: 4x AAA alkaline batteries.
- Back-Up Type-C Unlock: Available.
- Size: 82.5mm width, 138mm length, 57.6mm height.
- Service: OEM and ODM service available, Including offering APP SDK file and API.

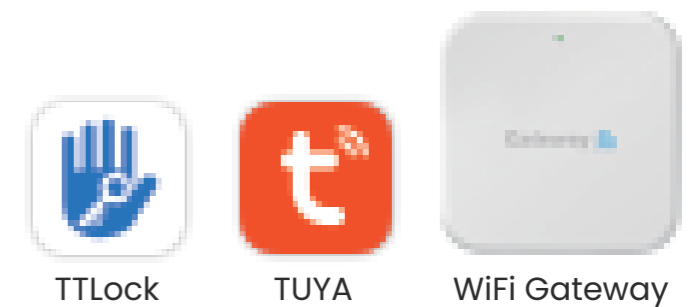
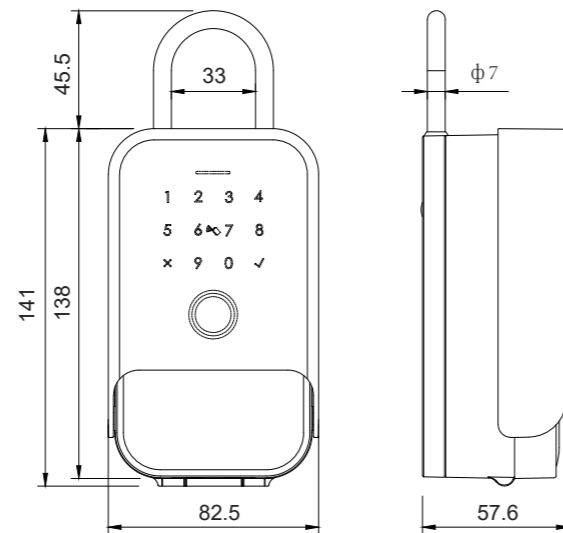
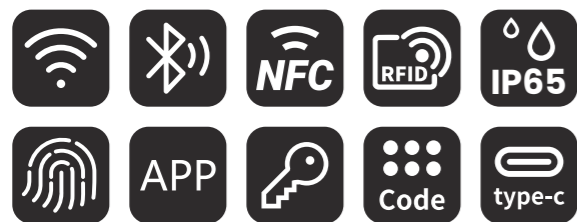

- Emergency mechanical key.
Back-Up Type-C Unlock.



- Protective Outer Shell for Dust & Weather Resistance
- Sealed Cover Guards Keypad & Fingerprint Sensor





SMART KEY BOX

- Material: Aluminum Alloy.
- Finish: Black or White.
- Unlock Methods: TUYA/TTLOCK apps, BLE distance unlock, Fingerprint unlock, Passwords unlock, RFID card/NFC, Emergency mechanical key.
- Application: B&B, home use.
- Certification: CE, FCC, RoHS.
- IP Rating: IP66 waterproof.
- Battery: 4x AA alkaline batteries.
- Back-Up Type-C Unlock: Available.
- Size: 87mm width, 145mm length, 55mm height.
- Service: OEM and ODM service available, Including offering APP SDK file and API.

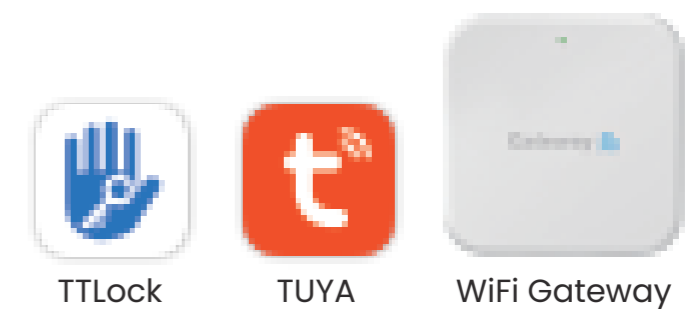
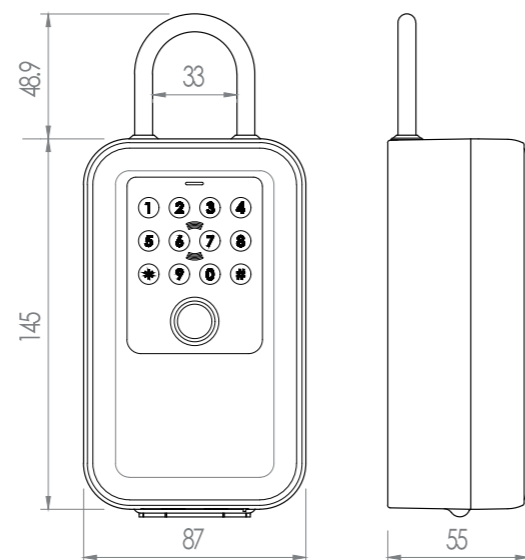

IP66

WATERPROOF DESIGN

Working temperature:
-25 degrees to 70 degrees.

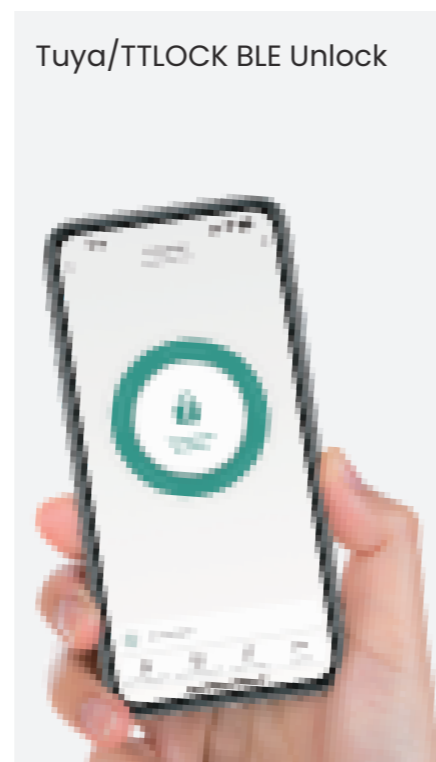
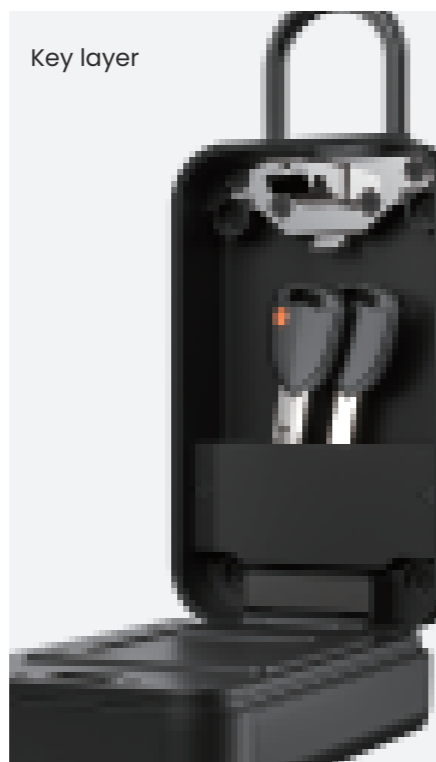
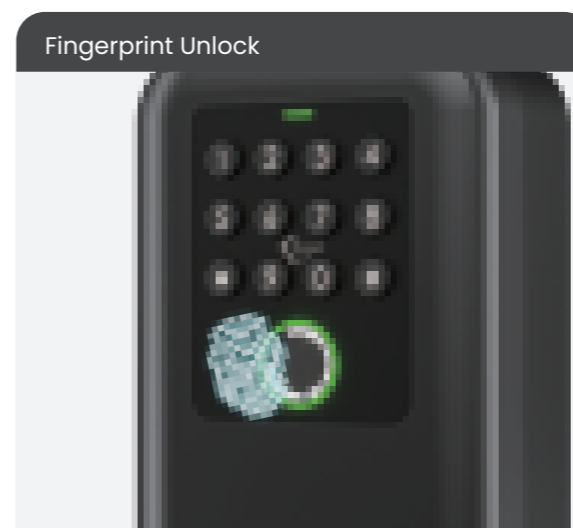

SMART CYLINDER PROTECTOR

- No App required.
- No Battery on the protector.
- Simply add/delete the smart key.
- OEM and ODM service available.



Stainless Steel



Antique Brass



Black



Golden



EPI Protector



Key Encoder

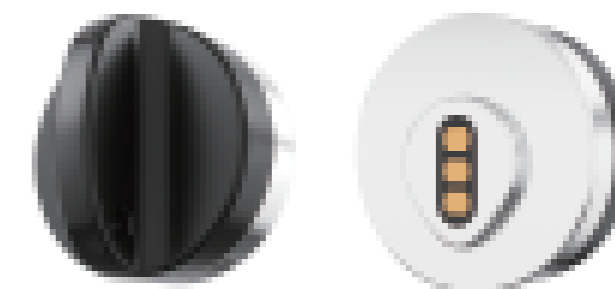

Encrypted Key



Anti-Drilling



Anti-Bump



Anti-Pick



Anti-Topolino



Anti-Break



Anti-Corrosion

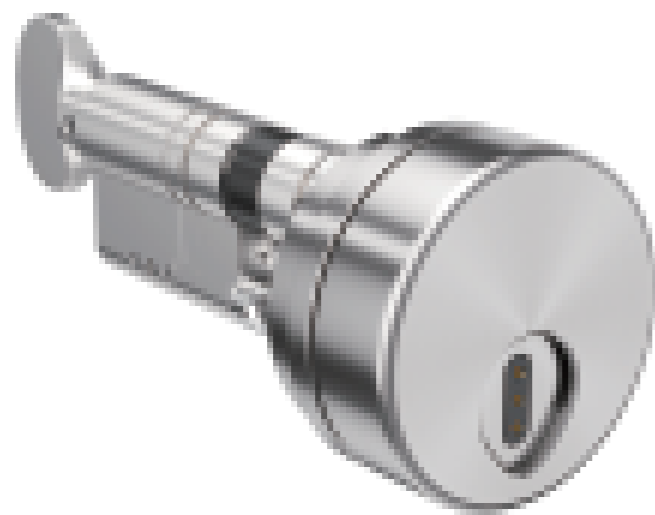

Cylinder is protected by EPI



It can be easily turned after the encrypted key is activated

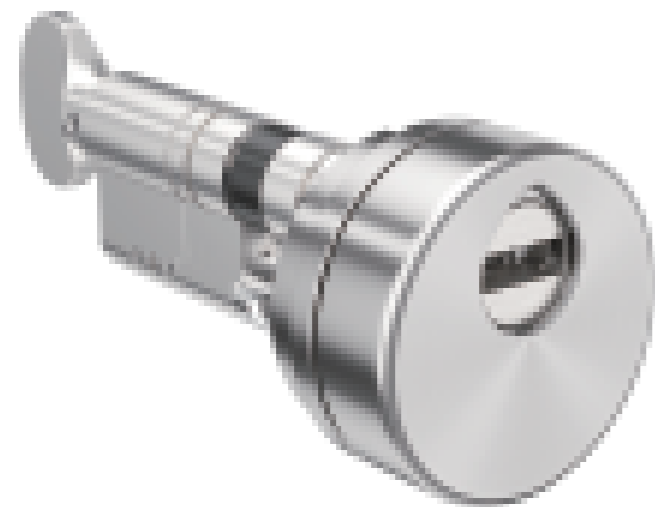

Expose the keyhole

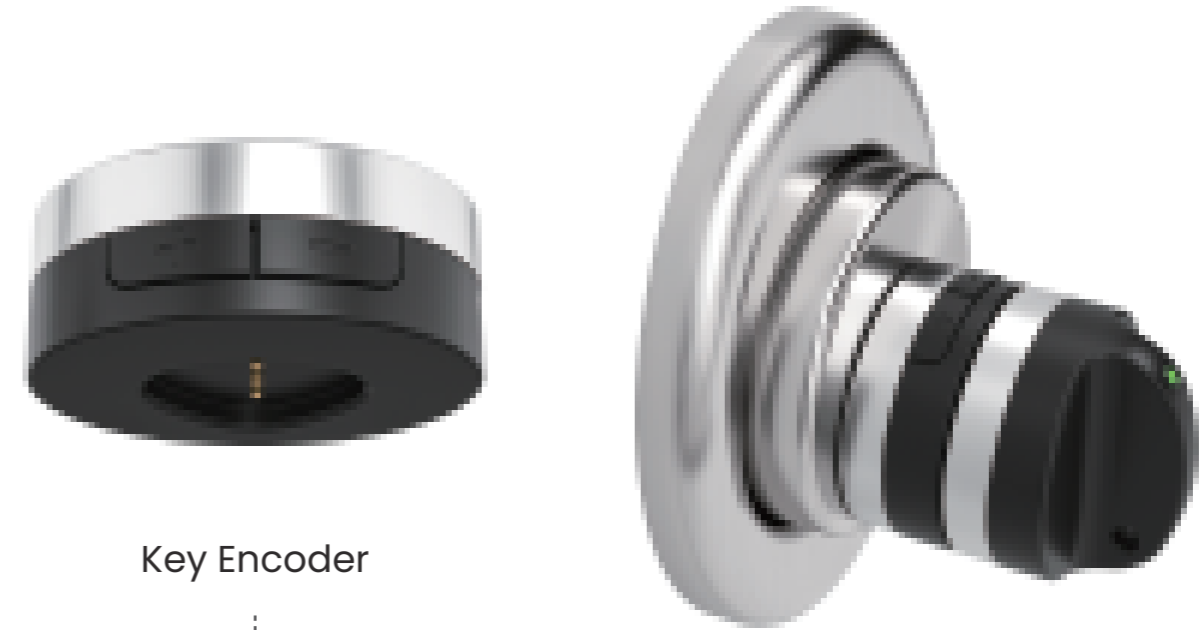

Key Encoder

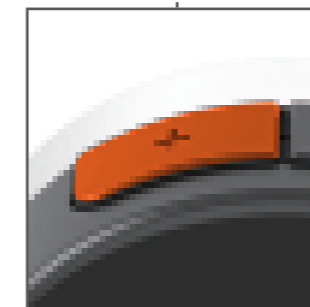

- Add Key by Pressing the "+" Button
- Maximum 20 Keys

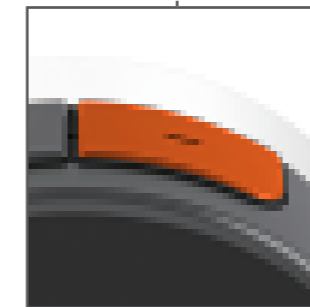

- Delete Key by Pressing the "-" Button
- Press the "-" Button for 5 Seconds to Clear All the Keys



Type-C charging



SMART RIM LOCK

- Options for Inside Devices: (R1-S) Button with Thumbturn OR (R1-D) Cylinder (Key) with Fingerprint and Card.
- Automatically Lock (Closing).
- Alarm Function Optional.
- TUYA/TTLOCK apps remote unlock (through Gateway), BLE distance unlock, Passwords unlock, Fingerprint unlock, RFID card/NFC unlock, Mechanical key unlock.
- Card type: MIFARE Classic® S50 card, 13.56Mhz. ISO14443A.
- CE, FCC, RoHS, IP55 certified.
- IP55 Waterproof. Working temperature: -25 degree to 70 degree.
- 4 pcs of Number 5 (AA) batteries and 1-year battery life.
- OEM and ODM service available, including offering APP SDK file and API.

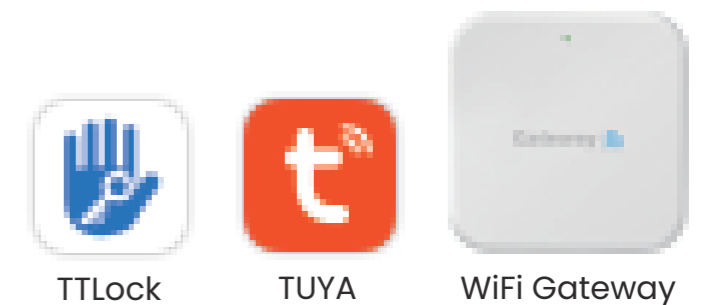
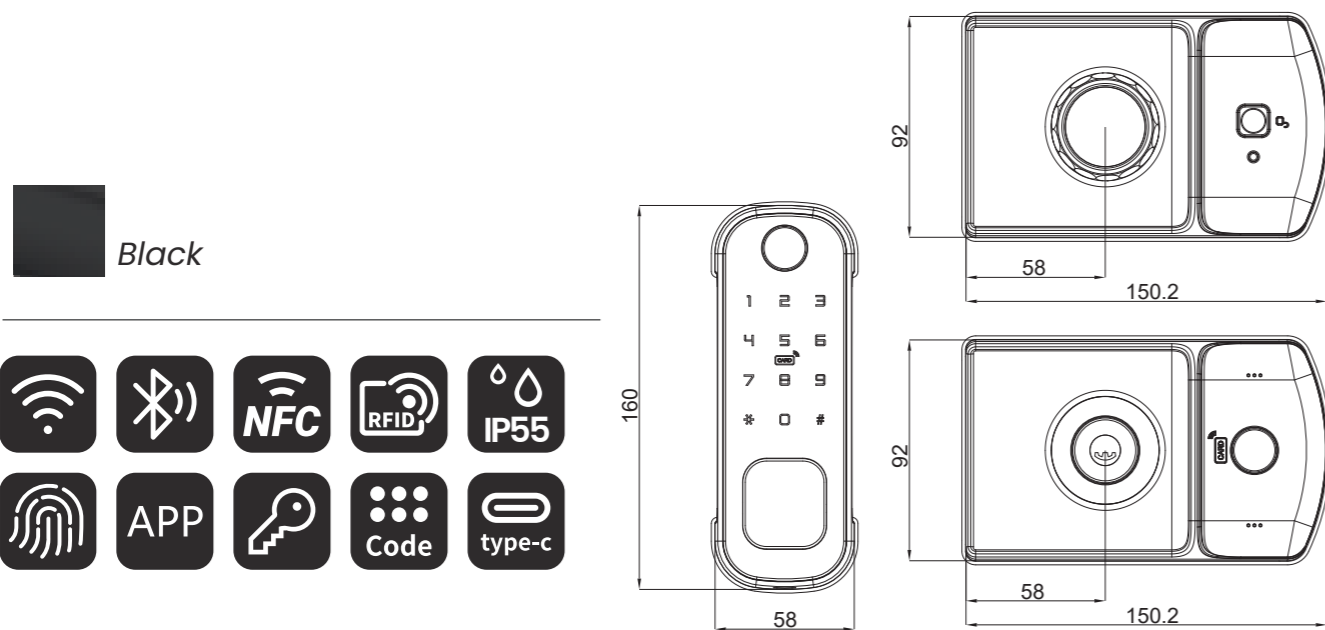

KP1

KEYPAD



TTLock

- Bluetooth Standard: Bluetooth 5.4 BLE
- Supporting systems: Android 4.3/iOS 7.0 or above
- Power supply: 4 AAA
- Standby current: $\approx 20 \mu A$
- Working voltage: 6V
- Working temperature: $-20 \sim 50^{\circ} C$
- Maximum number of supported fingerprints: 100
- Maximum number of supported bonding locks: 3

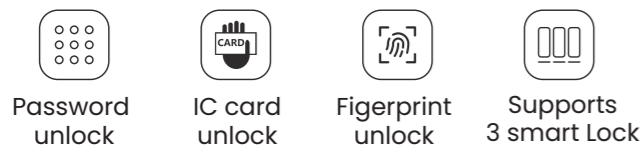

Black

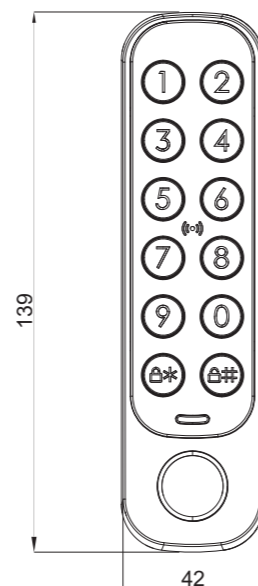

G2/G5

WI-FI GATEWAYS



TTLock



- Network: G2-Wifi 2.4 GHz
G5-Wifi 5 GHz
- IEEE Standard: 802.11 b/g/n
- Power Interface: USB-C
- Power Input: DC 5V/500mA
- Dimensions: 70 X 70 X 26 mm

White

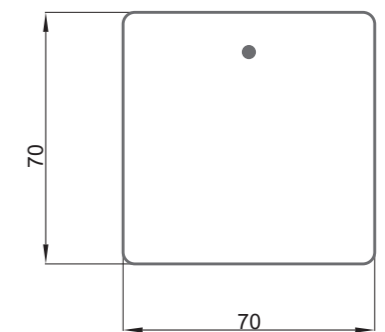

DS2

DOOR SENSORS



TTLock



- Material: ABS plastic
- Frequency: 2.4GHz
- Battery model: CR2032
- Voltage: 3V
- Battery life: 2 years (10 times a day)
- Standby current: <math><5\mu\text{A}</math>
- Induction range: <math><22\text{mm}</math>

White

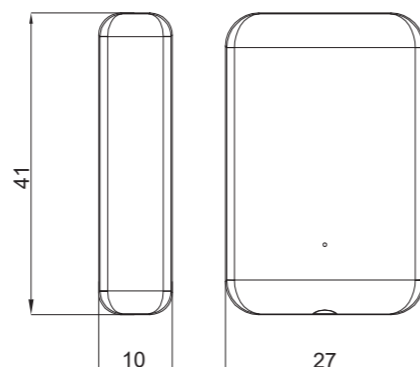

 ELEKSEC

STAY TUNED FOR MORE NEW PRODUCTS



Company: Zhongshan City EOS Secure Products Co., Ltd.
Email: winny@eos-secure.com
Mobile: +86 13420436003
Add: No.29 Ronghua South Road, Xiaolan Town,
Zhongshan City 528415, Guangdong, China